



REFUso/<sup>®</sup> – solar inverter  
REFUso/<sup>®</sup> 008K bis 20K

Operating instructions

Version 08.1

**REFU**so/

Title	<b>REFUso<sup>®</sup></b> – Solar Inverters
Type of Documentation	Operating Instructions
Published by	REFUso/ GmbH Uracher Straße 91 • D-72555 Metzingen Telephone: +49 (0) 7123 969-102 • Fax +49 (0) 7123 969-333 <a href="http://www.refusol.com">www.refusol.com</a>
Legal Disclaimer	All details in this documentation have been compiled and checked with utmost care. Despite of this, faults or deviations based on technical progress cannot be completely excluded. We therefore do not accept any liability for their correctness.  The relevant up-to-date version can be obtained from <a href="http://www.refusol.com">www.refusol.com</a> .
Copyright	The details of this documentation are the property of REFUso/ GmbH. Using and publicising this documentation, even if only in parts require the written consent of REFUso/ GmbH.
Trade Mark	<b>REFUso<sup>®</sup></b> is a registered trademark of REFUso/ GmbH

Marking	Date of Issue	Remarks
BA_REFUSOL 008K_020K_V08.1_EN		2012-10-11 MR

# Table of Contents

<b>1</b>	<b>Regarding these operating instructions.....</b>	<b>6</b>
1.1	Symbols and Markup .....	6
1.2	Warning notices .....	6
1.2.1	Lay-out of a warning notice.....	6
1.2.2	Categories of warning notices .....	6
1.3	Notices .....	7
<b>2</b>	<b>Safety notices.....</b>	<b>8</b>
2.1	Proper usage .....	8
2.2	Qualification of personnel .....	8
2.3	Dangers arising from misuse .....	8
2.4	Protection against touching electrical parts .....	9
2.5	Protection against magnetic & electro-magnetic fields during operation & assembly..	10
2.6	Protection against touching hot parts .....	10
2.7	Protection during handling and assembly.....	11
2.8	Note before starting up .....	11
2.9	Disposal .....	12
<b>3</b>	<b>Description of REFUso<sup>®</sup> 008K to 020K.....</b>	<b>13</b>
3.1	Description of the Device .....	13
3.2	Scope of Delivery of the REFUso <sup>®</sup> 008K to 020K .....	14
3.3	Outside Dimensions of the REFUso <sup>®</sup> 008K to 020K .....	14
3.4	Block Diagram of the REFUso <sup>®</sup> 008K to 020K .....	15
3.5	Solar Inverter DC Connector .....	15
3.6	Reverse Current through Defective Modules .....	17
3.7	Control Panel .....	18
3.8	Internal Data Logger .....	18
<b>4</b>	<b>Installation .....</b>	<b>19</b>
4.1	Unpacking the Device .....	19
4.2	Assembly Site Requirements.....	19
4.3	Transport.....	21
4.4	Storage .....	21
4.5	Mounting the REFUso <sup>®</sup> 008K to 020K.....	21
4.6	Connectors on the Device .....	23
4.7	Power Connection.....	23
4.8	Power Supply Line .....	24
4.9	Grid line inductance .....	25
4.10	Grounding .....	26
4.11	Residual Current Protective Device.....	26
4.12	PV- Generator DC Connection .....	27

---

4.13	DC Connecting Line.....	27
4.14	Interface Port RS485 .....	28
<b>5</b>	<b>Commissioning.....</b>	<b>30</b>
5.1	Turn on the Device.....	30
5.2	Setting the Country Code and the Menu Language .....	31
5.3	Activating the Device .....	33
5.4	Navigation on the Control Panel.....	35
5.5	Password Entry.....	36
5.6	Menu Structure .....	39
5.7	ENS Test.....	46
<b>6</b>	<b>Configuration .....</b>	<b>48</b>
6.1	Reduction of the power output.....	48
6.2	Communication via Ethernet.....	48
6.3	Communication via RS485 .....	48
6.4	Portal monitoring.....	49
6.5	Sending Config .....	49
6.6	Server IP .....	49
6.7	Server port.....	49
6.8	Portal test function .....	49
<b>7</b>	<b>Troubleshooting.....</b>	<b>50</b>
7.1	Self-test Error Messages .....	50
7.2	Transient Failure .....	50
7.3	Faults .....	50
7.4	Fault Acknowledgement .....	50
7.5	List of Fault Messages.....	51
<b>8</b>	<b>Options .....</b>	<b>56</b>
8.1	Power Plug.....	56
8.2	Radiation and temperature Sensor.....	56
8.3	Remote Monitoring System .....	57
8.4	Instrument settings for monitoring with SolarLog® or MetoControl® .....	58
8.5	Data Logger Parameters .....	59
8.6	Power Cap .....	60
8.7	Connecting the AC-Adaptor Electrically to the Additional Power Cap.....	62
<b>9</b>	<b>Maintenance .....</b>	<b>63</b>
<b>10</b>	<b>Technical Data.....</b>	<b>64</b>
10.1	Inverters .....	64
10.2	Radiation and temperature sensor .....	66
10.3	Power Cap .....	67

<b>11 Contact.....</b>	<b>68</b>
<b>12 Certificates .....</b>	<b>69</b>
<b>13 Notes .....</b>	<b>70</b>

# 1 Regarding these operating instructions

The operating instructions form a part of the product



- ⇒ Read the operating instructions before using the product.
- ⇒ Keep the operating instructions readily available with the device for the entire life expectancy of the product.
- ⇒ Provide access to the operating instructions to all future users of the device.

## 1.1 Symbols and Markup

☑	Pre-condition
⇒	One-step operating instruction
1.	Multiple-step operating instruction
•	Bulleted list
<b>Highlighting</b>	Highlighting within a text
↪	Result

## 1.2 Warning notices



### 1.2.1 Lay-out of a warning notice

 <b>WARNING TEXT</b>	<p>The type and source of danger are described here.</p> <p>⇒ Measures for avoiding the danger are shown here.</p>
<b>Example</b>	
 <b>DANGER</b>	<p><b>Death or severe injury to persons due to high discharge current when opening the device.</b></p> <p>⇒ It is essential to ensure an earthing connection has been established prior to connection to the supply current circuit.</p>

### 1.2.2 Categories of warning notices

There are three categories of warning notices

 <b>DANGER</b>	<p>"DANGER" designates a safety notice, disregarding which will lead directly to death or severe bodily injury being sustained!</p>
--	---

 <b>WARNING</b>	"WARNING" designates a safety notice, disregarding which can lead to death or severe bodily injury being sustained!
 <b>CARE</b>	"CARE" designates a safety notice, disregarding which can lead to material damage or light bodily injuries being sustained!

### 1.3 Notices

---



**Notice:** A **notice** describes information which is important for the optimum and cost-effective operation of the equipment.

---

## 2 Safety notices

### 2.1 Proper usage

The REFUso<sup>®</sup>, referred to in these operating instructions as the inverter, is a solar inverter, which transforms the direct current generated by the PV generator (photovoltaic modules) into alternating current and feeds this to the public power supply network. The inverter has been constructed according to the current state of technology and in line with the rules of technical safety. Any use beyond this is not deemed to be proper. The manufacture will not accept liability for any damages resulting from this and the user alone will bear all responsibility.

### 2.2 Qualification of personnel

Only suitably trained and qualified personnel are allowed to work on this inverter. Personnel are regarded as being qualified if they are sufficiently familiar with the assembly, installation and operation of the product as well as with warnings and safety measures according to these operating instructions.

Furthermore, they will have been trained, instructed or authorised to switch electric circuits and devices on and off, to earth these and to identify them for their designated purpose in line with working requirements. They must be in possession of suitable safety equipment and be trained in first aid.

### 2.3 Dangers arising from misuse



**DANGER**

#### **Danger to life from electric shock**

⇒ Device may only be installed and serviced by qualified specialist technical personnel.

---



**DANGER**

#### **Danger to life from electric shock**

**After the device has been switched off, the interior may still contain life-threatening voltage.**

⇒ Do not open inverter.

---



**DANGER**

#### **Danger to life from electric shock**

⇒ Carry out connections carefully.

---



**DANGER**

#### **Danger to life from high discharge current**

⇒ It is essential to ensure an earthing connection has been established prior to connection to the supply current circuit!

---





**WARNING**

**Danger to health for persons with pace-makers, metallic implants and hearing aids in direct proximity to electrical equipment.**

⇒ Corresponding circle of persons must consult their doctor beforehand.

---



**WARNING**

**Danger of burns!**

**Machine housing surfaces may be hot!**

⇒ Allow hot surfaces to cool down.

---



**WARNING**

**Danger of bodily injury through crushing, shearing, cutting, striking.**

⇒ Assembly of the device with two persons.

---

## 2.4 Protection against touching electrical parts

---

**Danger to life, danger of injury due to high electrical voltage**



**WARNING**

- ⇒ Installation of the inverter must only be carried out by trained specialist personnel. In addition, the installer must be accredited by the responsible energy provision company.
  - ⇒ Operation, maintenance and/or repair of the inverter must only be carried out by personnel trained and qualified to work with electrical devices.
  - ⇒ General assembly and safety stipulations relating to working on high current facilities must be followed.
  - ⇒ Before switching on, a check must be made to ensure that the plugs are firmly in place (locking).
  - ⇒ The plugs of the PV generator must only be pulled out once when the DC circuit breaker is positioned at "OFF". The feeder must be isolated and secured against switching on again before the power plug is pulled out.
-

## 2.5 Protection against magnetic & electro-magnetic fields during operation & assembly

---

**Danger to health for persons with pace-makers, metallic implants and hearing aids in direct proximity to electrical equipment.**



**WARNING**

- ⇒ Persons with pace-makers and metallic implants must not as a rule enter areas in which electrical devices and parts are being assembled, operated or are being brought into service.
  - ⇒ Should people wearing pace-makers need to enter such areas, then the decision as to whether this is permitted is to be made by a doctor beforehand. The immunity from interference of pace-makers which have already been implanted or will be in the future varies greatly, meaning that no generally valid rules exist about this.
  - ⇒ Persons with metal implants or metal splinters as well as those with hearing aids must ask a doctor before entering such areas, as impairments to health are to be expected there.
- 

## 2.6 Protection against touching hot parts



**CARE**

---

**Danger of burns through hot surfaces and housings.**

The upper part of the housing as well as the refrigeration unit can reach a surface temperature of 75 °C with a surrounding temperature of 45 °C.

- ⇒ Do not touch housing surface near to hot sources of warmth.
  - ⇒ Allow the device to cool down for 15 minutes before touching the surface of the device.
-

## 2.7 Protection during handling and assembly



### WARNING

**Danger of injury with improper handling through crushing, shearing, cutting, striking and raising.**

The weight of the inverter amounts to 40 kg!

- ⇒ Follow the general instructions for assembly and safety whilst handling and setting up.
- ⇒ Use suitable assembly and transportation equipment.
- ⇒ Avoid pinching and crushing by taking suitable precautions.
- ⇒ Only use suitable tools. Use special tools where this is prescribed.
- ⇒ Use lifting equipment and tools in a technically correct manner.
- ⇒ If necessary, use suitable protective equipment (for example, goggles, safety shoes, protective gloves).
- ⇒ Do not stand under hanging loads.
- ⇒ Remove any liquids escaping onto the floor immediately to avoid the danger of slipping.

## 2.8 Note before starting up

- In the event of installation in France, the device must be provided with the warning sticker laid down by UTE C 15-712-1. The warning sticker is included in the delivery.
- Problem-free and safe operation of the inverter is conditional upon due and specialised transportation, storage, assembly and installation as well as careful operation and maintenance.
- Only use accessories and spare parts approved by the manufacturer.
- Adherence must be ensured to the prescriptions and stipulations regarding safety of the country in which the inverter is to be used.
- The environmental conditions stated in the product documentation must be observed.
- Starting up is to be prohibited until the entire equipment corresponds to the national stipulations and safety rules regarding use.
- Operation is only permitted with adherence to the national EMC prescriptions for the present use case.
- The manufacturer of the equipment or machine is responsible for ensuring adherence to the thresholds required by the respective national stipulations.  
European countries: EC Directive 2004/108/EC (EMC Directive).
- The technical data, connection and installation conditions are to be taken from the product documentation and must be observed under all circumstances.
- Switching off of the inverter must first be effected on the AC side via the circuit breaker. Switch-off is then to be effected on the DC side via the DC circuit breaker, should maintenance work need to be carried out on the DC side. This ensures the life expectancy of the DC circuit breaker is increased.
- It is not necessary to switch off the inverter via the DC circuit breaker overnight, as the inverter

switches off completely as soon as no DC voltage is present at the input.

If no switch-off is effected via the DC circuit breaker, the inverter switches on automatically in the morning when the PV generator supplies sufficiently high voltage. This means that the maximum output is generated.

•

## 2.9 Disposal



Dispose of the packaging and replaced parts according to the rules applicable in the country where the device is installed.

Do not dispose of the inverter with normal domestic waste.

The inverter complies with the RoHS Directive. That means that the device can be delivered to local sites for the disposal of household appliances.

REFUso/ GmbH takes the inverter completely back. Please contact the Service!

## 3 Description of REFUso/® 008K to 020K

### 3.1 Description of the Device

The REFUso/® is a three-phase solar inverter without a transformer, which has a particularly high efficiency at any operating point and is suitable for the connection of a PV generator with a power of 8.8kW up to 21.2 kW. Heat is dissipated only by convection, with an internal temperature monitor protecting the device against exceeding the permissible ambient temperature. The inverter is designed such that the device does not have to be opened for assembly and connection work. All electrical connections are exclusively made with lockable connectors. The device features an integrated DC isolating switch according to EN 60947-3, which considerably reduces the overall installation work. The inverter provides the usual communication interfaces RS485 and Ethernet. An illuminated graphical display shows the development of the feed power and other operating data in a clearly arranged manner. An 8-key control panel below the display provides excellent and comfortable control and navigation features. Based on its design in protection class IP 65, the inverter can be installed at almost any outside location.



Figure No. 1 REFUso/® 008K to 020K

### 3.2 Scope of Delivery of the REFUsol<sup>®</sup> 008K to 020K

The scope of delivery of the REFUsol<sup>®</sup> includes a wall-mounting bracket and an enclosed bag 0030532 containing:

- 1 x 5-pin contact insert, IP67, VC-TFS5-PEA
- 1 x adapter housing, IP67, VC-K-T3-R-M25-PLOMB
- 3 x U-washer, shape B, M8, DIN125-8
- 1 x cable gland, Schlemmer-Tec, M25x1.5/21532
- 2 x cross-recessed flat-head screw, M5x20 => for mechanically securing the device in the wall bracket
- 1 x warning label in according UTE C 15-712-1 for installing in France

The IP67 VC-K-T3-R-M25-PLOMB adapter housing allows sealing according to DK4940.

The seal is run through a hole in the screw (below the screw head of the adapter housing) and the opening provided and attached to the housing of the device.

### 3.3 Outside Dimensions of the REFUsol<sup>®</sup> 008K to 020K

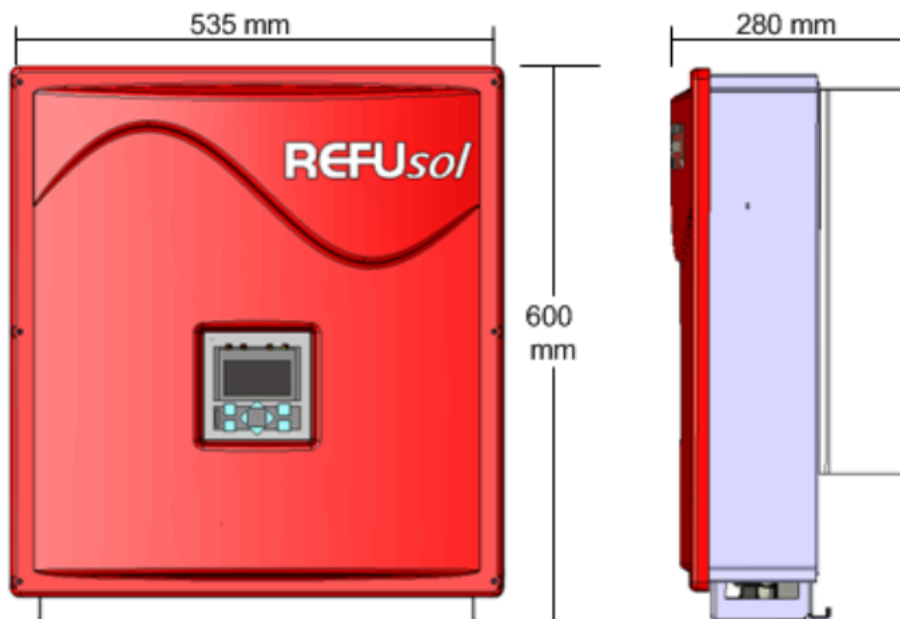

Figure No. 2 REFUsol<sup>®</sup> 008K to 020K

### 3.4 Block Diagram of the REFUso<sup>®</sup> 008K to 020K

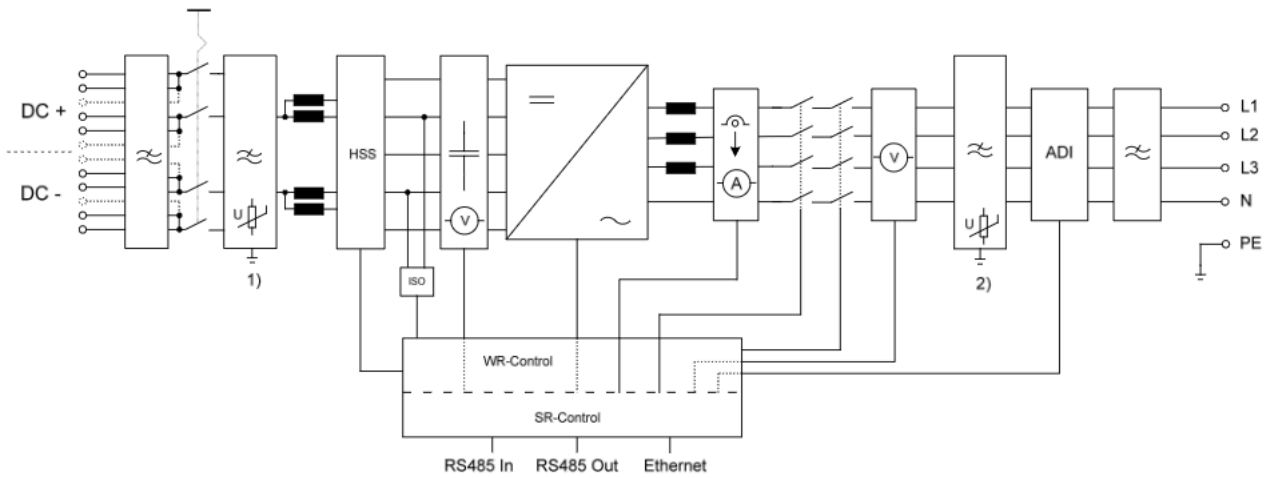

Figure No. 3 Block diagram of the REFUso<sup>®</sup> 008K to 020K

- 1) DC overvoltage protection, type 3
- 2) AC overvoltage protection, type 3

### 3.5 Solar Inverter DC Connector

The PV generator may not exceed the following operational characteristics under any circumstances!

Device type	008K	010K	13K	017K	020K
Max. DC voltage at each input	1000 V				
Max. current for each DC input pair (008K to 013K ) and DC input triplet (017K to 020K), respectively	25 A				
Max. DC current at the input across all connections	23 A	25 A	30 A	38,5 A	41 A

To keep the maximum current allowed of 25A at the DC Circuit breaker contacts, observe the following input assignments.

The power of the PV generator must be uniformly distributed over all 3 inputs (008K to 010K), 4 inputs (013K) or 6 inputs (017K to 020K). The maximum DC current of 36 A / 41 A may not be exceeded.

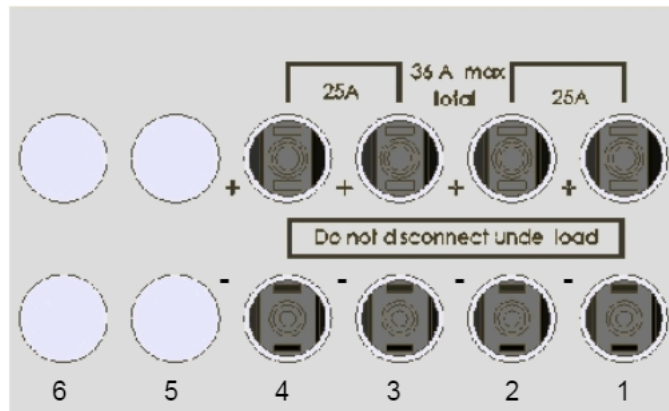

Figure No. 4 PV generator connector REFUSol® 013K

2 PV connecting lines → inputs 1 and 3 or inputs 2 and 4

3 PV connecting lines → inputs 1, 2 and 3 or inputs 1, 3 and 4

4 PV connecting lines → inputs 1, 2, 3, 4



Note: Not observing the requirements may result in a malfunction and damage to the DC-Circuit breaker and thus the warranty deemed void!



Note: Should all DC inputs not be occupied, then the open inputs are closed with MC4 closure caps. By Not observing these requirements the IP65 protection class can not be guaranteed! Both caps (+/-) can be ordered at any time under the part no. 0028991 and 0028992 from Refuso/ GmbH.

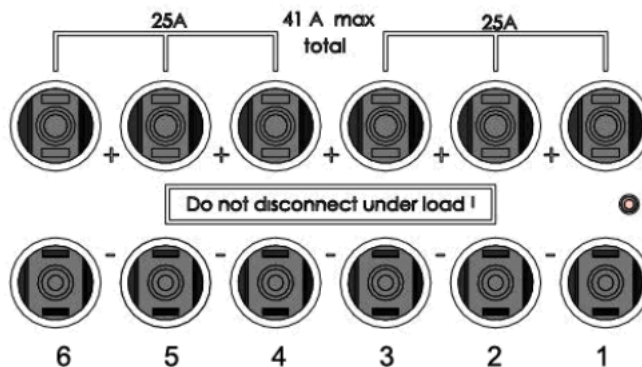

Figure No. 5 PV generator connector REFUSol® 017K to 020K

3 PV connecting lines → inputs 1, 3 and 5 or inputs 2, 4 and 6

4 PV connecting lines → inputs 1, 3, 5 and 6 or inputs 2, 3, 5 and 6



If several PV connecting lines are available, the connections can be made as desired.

---



**WARNING**

**When using the solar inverter without transformer, do not ground the positive or negative pole of the PV generator!**

---

### 3.6 Reverse Current through Defective Modules

Reverse currents are fault currents that only occur in PV systems comprising parallel strings. Given short circuits of individual modules or cells in a module, or a double ground fault, the open circuit voltage of the string in question can drop (e.g. due to defective modules or parts of modules) so far that the intact parallel strings will drive a reverse current through the defective string. This may result in strong heating and therefore to a destruction of the string.

What is more, the reverse current may cause secondary damage.

To prevent such damage to PV systems, appropriate precautionary measures should be taken. There are the following two cases:

1. The PV system is designed such that the reverse current which is flowing in case of a failure and consists of the sum of the short-circuit currents of all intact strings in the worst case does not result in the destruction of the damaged string and therefore in secondary damage either. The decisive factor here is the current carrying capacity of the system components (connectors, lines) and the reverse current carrying capacity of the modules. The appropriate data can be found in the manufacturer's data sheet. In this case, it is not necessary to take any further measures.
2. The PV system is designed such that the reverse current flowing in case of a failure exceeds the destruction limit. In this case, each string must be separately protected by a string fuse connected in series with the other string fuses. In case of a failure, this isolates the string from the intact strings so that destruction is prevented.

### 3.7 Control Panel

The graphical user interface which is integrated on the front of the device and comprises 128 x 64 pixels can be used to display the development of interesting data, such as the feed power. The parameters required are selected and entered on the 8-key control panel the control panel is illuminated on pressing a key and turns dark automatically.

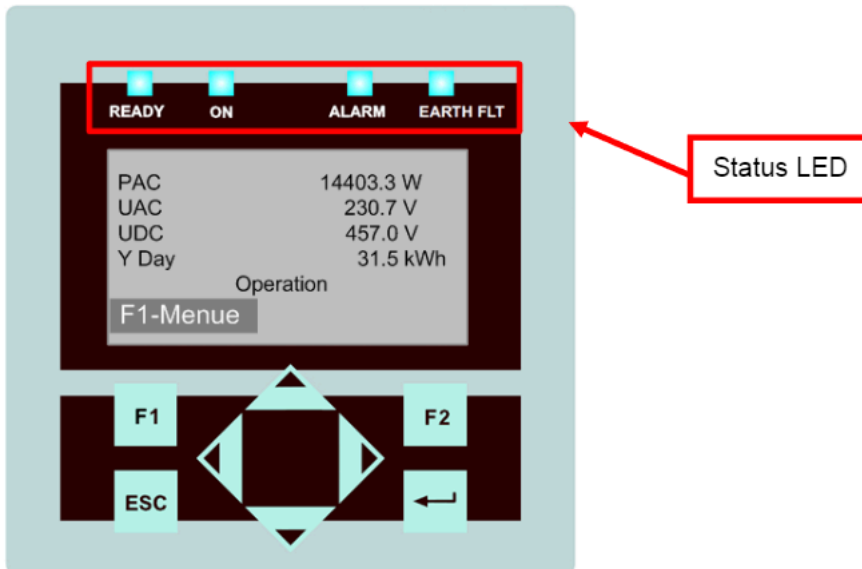

Figure No. 6 Control panel

F1: Display the menu.

◀▶: Function in the menu: jump to the first or last menu item.

Function while parameters are edited: digit to the left, digit to the right (decade jump).

▲▼: Select the menu.

ESC: Acknowledge failures and delete entries.

↵: Confirm the selected menu and entered data.

### 3.8 Internal Data Logger

The inverter features an internal data logger that allows measured values to be simultaneously recorded in the form of parameters. The data logger is implemented as a ring buffer. If this buffer is full, the oldest data is overwritten. With the default setting on delivery, the data logger logs 16 measuring channels.

Recording cycle	Storage time
1 minute	6 months
2 minutes	12 months
5 minutes	2,5 years
10 minutes	5 years

## 4 Installation

### 4.1 Unpacking the Device

The inverters are loaded at their head and packed upside down facilitate transport. You will therefore see the bottom side of the device (connectors) after having opened the package. Take the device at the two holding grips that are visible on the side and remove it from the packaging. When being unpacked, the device keeps the packaging grid locked in place on its housing. The packaging grid can be used to deposit the device on the floor. This prevents the cover from being damaged.

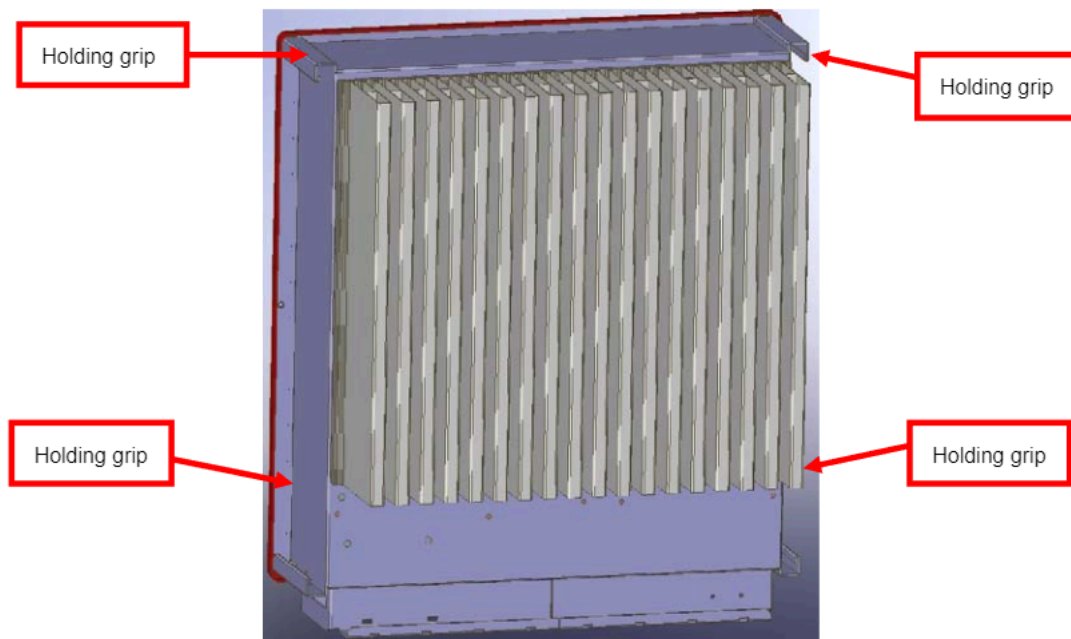

Figure No. 7 Rear panel of REFUSol<sup>®</sup> 008K to 020K

### 4.2 Assembly Site Requirements

The inverter is provided with mere convection cooling and is therefore designed for attachment to a vertical wall. The device is attached by means of a self-centering wall-mounting plate.



#### WARNING

To prevent accidents when installing and servicing, free and safe access to the devices must be ensured.

- The assembly site must be shaded.
- The device may only be mounted in a vertical position.
- For the assembly is to choose a solid wall or metal construction, which comply the fire-protection class F30 and the load capacity of 40kg per unit. Relevant provisions of construction regulations must be observed!

- Mount the device at an appropriate distance from combustible materials.
- We recommend that you mount the device at eye level to ensure optimum user comfort.
- Owing to its protection type (IP65), the device can also be mounted in outside areas.



Note: To ensure protection class IP65, only use the male and female connectors provided for connecting the inverter and connect them according to the connector manufacturer's mounting instructions. To protect against penetrating moisture and dirt, unused inputs and outputs must be properly closed. Failure to observe these specifications could void your warranty!



Note: Do not cover the cooling ribs of the heat sink. Failure to observe this specification could void your warranty.

- To allow for the heat dissipation required, keep the following minimum distances from the ceiling and wall as well as from neighbouring devices.

Minimum distances	At the sides	50 mm or 1.9685 inches	At the top	500 mm or 19.685 inches	At the bottom	500 mm or 19.685 inches
-------------------	--------------	------------------------	------------	-------------------------	---------------	-------------------------

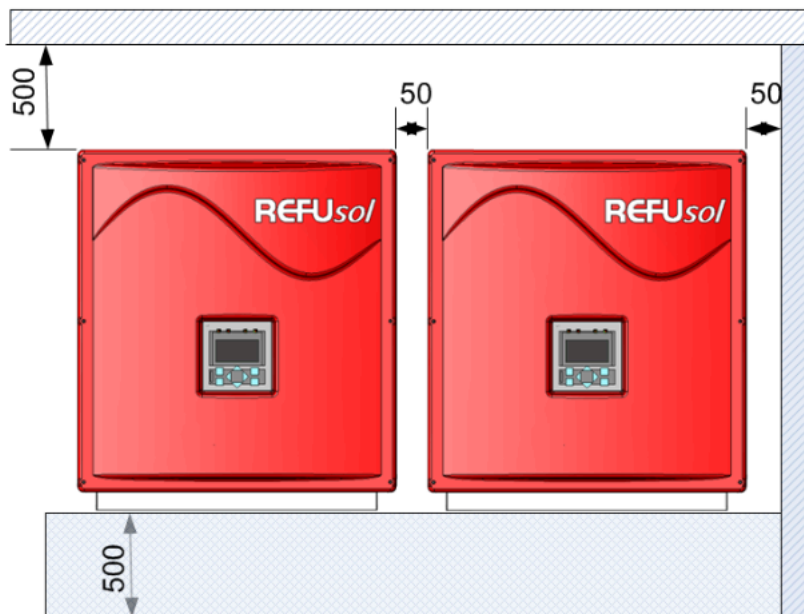

Figure No. 8 Minimum distances



**CAUTION**

Inverters should in no case be mounted on top of each other without a Power Cap otherwise the convection cooling will be affected!

### 4.3 Transport

The devices must be transported under clean and dry conditions, if possible in their original packaging. The transport temperature must be between  $-25\text{ °C}$  and  $+70\text{ °C}$ . Permissible variations in temperature may not exceed 20 K per hour.

### 4.4 Storage

The devices must be stored in clean and dry rooms, if possible in their original packaging. The storage temperature must be between  $-25\text{ °C}$  and  $+55\text{ °C}$ . Permissible variations in temperature may not exceed 20 K per hour.



Note: The REFUsol<sup>®</sup> contains electrolyte capacitors which can be stored for no more than 2 years and at a storage temperature of  $\leq 40\text{ °C}$  while they are in a de-energized state.

If the storage time of two years has been exceeded, please contact the REFUsol Service before connecting the REFUsol<sup>®</sup> to your system!

### 4.5 Mounting the REFUsol<sup>®</sup> 008K to 020K

Mount the inverter by means of the self-centering wall-mounting plate which is included in the scope of delivery.

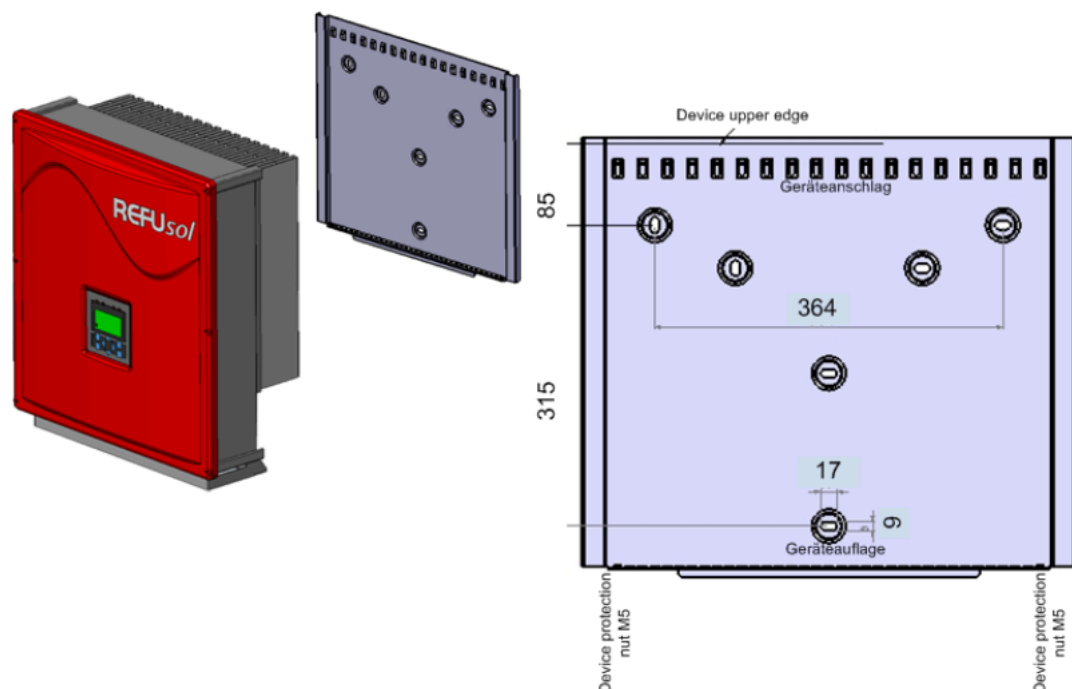

Figure No. 9 Mounting the inverter



**DANGER**

**You should not open the device!**

**If this is not observed then dust, dirt and also humidity can penetrate or components be damaged by an electro-static discharge and the degree of protection IP 65 is then no longer guaranteed.**

**There is subsequently no warranty for resulting damages!**

---



Remark: While selecting the place of assembly, a free and unobstructed access for servicing the inverter must be considered.

Otherwise the operator or installation engineer must provide suitable technical auxiliary means for servicing.

---



**CAUTION**

**Any failure to observe these requirements may result in a malfunction of the device or may even cause severe personal injuries through crushing, shearing, cutting, striking, or fire!**

---

When designing the attachment of the wall-mounting plate, take the weight of the inverter of 40 kg into account.

- Mounting the wall bracket: Use the wall bracket to mark the positions of the holes to be drilled. Attach the mounting plate to the wall with the outer holes.
  - Insert the upper edge of the cooler into the recess of the device holder. Push the inverter upwards until it stops and place the lower edge of the cooler onto the wall holder. Ensure that the rib profile is locked behind the nuts. Finally secure the inverter in these nuts using the enclosed screws (M5x20). As an alternative, you can also use a padlock (shackle 4 mm in diameter) as anti-theft protection. The design of the wall bracket ensures that the inverter is automatically centered in this bracket.
  - To avoid adhesive residue on the inverter, we recommend to remove the display protector of inverter immediately after assembly from the display.
- 



**CAUTION**

**Avoid any load on the edge of the cover while mounting the device!  
Do not use the cover to hold the device!  
Only use the four holding grips to move the device!**

---

## 4.6 Connectors on the Device

The following figure shows the connectors of the inverter on its bottom side.

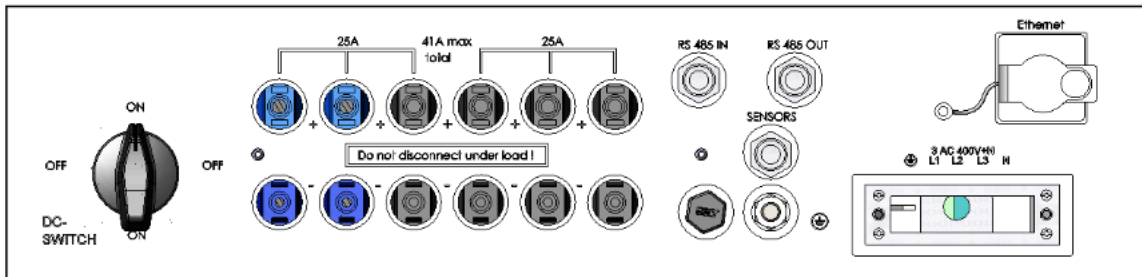

Figure No. 10 Device connectors

The REFUSol<sup>®</sup> is provided with the following connectors, as seen from left to right:

- 4/6 pairs of PV generator connectors
- SENSORS (connection: radiation and temperature sensors)
- RS 485 connectors (IN and OUT)
- Ethernet interface port
- Power connection

## 4.7 Power Connection



**CAUTION**

**Risk of electric shock and fire caused by high leakage current!**

**Before connecting the device to the supply circuit, establish a ground connection by means of the labeled ground stud!**

The following mains systems are suitable:

TN-C-Net	suitable
TN-C-S-Net	suitable
TN-S-Net	suitable

The power supply line must be equipped with an appropriate line protection. More information regarding the power connection you will find in Chapter 10 the Technical Data. Reducing factors must be taken into account if circuit breakers are connected in series. Always observe the following standards:

DIN VDE 0298-4	Types of cable placement and current-carrying capacity
DIN VDE 0100; Part 430	Protective measures: protection of cable and cords against over current
DIN VDE 0100; Part 410	Protective measures: protection against electric shock

Also observe the following requirements specified by the local network operator:

- Pertinent technical and special rules and regulations
- The installation approval must be submitted.

**CAUTION**

**Before connecting the inverter to the AC network, isolate the power connection, verify that the system is de-energized, and protect the circuit breaker against reactivation.**

- Check the line voltage, which may not exceed 265 V (phase against neutral conductor). If the line voltage is higher than 265 V, contact your local network operator.
- Apply the power cable to the supplied connector as illustrated, connect the power cable to the inverter and fasten the connector.



**Note:** When using wire end ferrules with isolating collar, make sure you do not introduce the insulation of the wire end ferrule into the clamping area of the terminal.

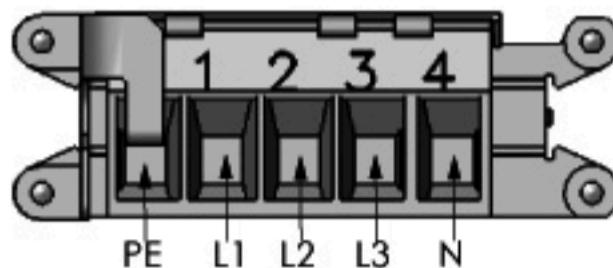

Figure No. 11 Power connection

## 4.8 Power Supply Line

Select the cross-section of the power supply line such that line losses are as low as possible.

- However, observe the following points:
  - Due to the construction, the recommended feed line for all cross-sections is a fine-strand line.
  - The cable fitting of the standard connector housing supplied allows a 5 x 6 mm<sup>2</sup>



cable to be connected. The maximum outside diameter of the power supply line may be 18 mm (e.g. Lapptherm 145, 5 x 6 mm<sup>2</sup>).

- Optionally, you can also order a larger connector housing allowing connection of a 5 x 10 mm<sup>2</sup> power supply line.

The table below shows the maximum line lengths in relation to the conductor cross-section with a voltage drop of  $\leq 1\%$ .

Line cross section	4.0 mm <sup>2</sup>	6.0 mm <sup>2</sup>	10.0 mm <sup>2</sup>
Max. line length	20 m	30 m	50 m



Note: To ensure protection class IP65, the connectors and power supply lines must be matching each other and all unused connections must be provided with blanking plugs.

## 4.9 Grid line inductance

For better efficiency, large line cross-sections and single wire cables are increasingly used for power supply lines, especially if local conditions require long supply lines.

The considerable line lengths between REFUSol and the transformer station result in a high cable inductance and therefore an increased line impedance. This presents high resistances for harmonics of the fundamental frequency (50 Hz) of the line voltage and causes voltage distortions in the inverters as well as error messages with regard to:

- controller voltage,
- line frequency,
- line overvoltage, and
- sometimes increased operating noise of the transformers.

To avoid these disadvantageous conditions, twisted lines should be used for power supply if possible. If laying of twisted lines is not possible, the following requirements must be met for single cores:

- The spacing between single cores may not be too large.
- It is not allowed to lay single cores in closed, magnetically conducting materials (e.g., sheet steel pipe).
- If laid in open cable ducts, single cores should be laid such that the spacings between them are as small as possible.

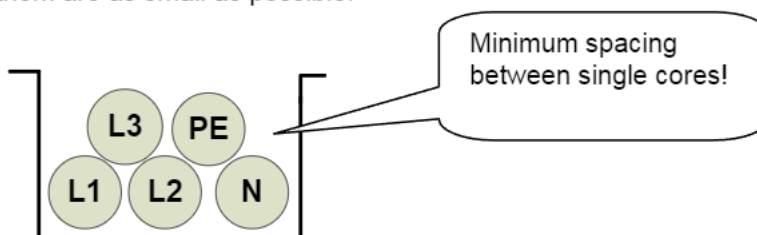

- Single cores should not be laid along magnetic materials.



Note: The sum total of the ohmic and inductive voltage drops on the power supply line at nominal load should not exceed 1% of the line voltage. It must be ensured that the line inductance remains  $< 30 \mu\text{H}$ .

## 4.10 Grounding



CAUTION

Risk of electric shock!

The REFUSol<sup>®</sup> must be connected to the ground stud. Otherwise, a voltage gradient may develop, which may result in electric shock!

The inverter features a threaded bolt below the power supply port on the connection side for additional grounding. Grounding is intended to ensure optimum overvoltage protection. That is why the ground wire cross-section must be chosen in excess of the cross-section of the power supply line by a factor of one (at least  $10 \text{ mm}^2$ ). In addition, ensure that the ground wire is placed as far away from and not directly in parallel to the power supply line.

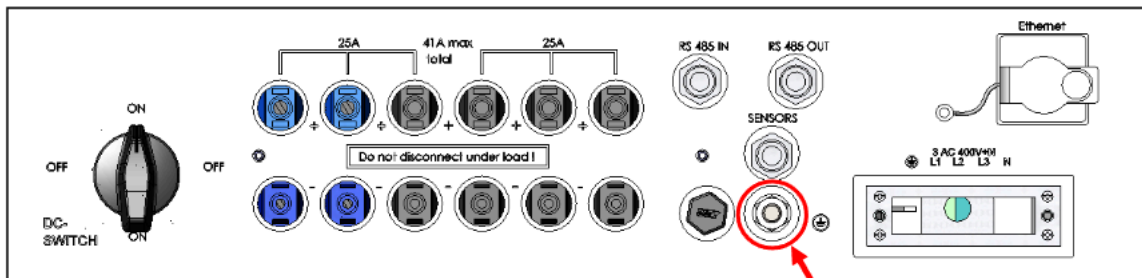

Figure No. 12 Grounding bolt

Grounding bolt (M8) PE

## 4.11 Residual Current Protective Device

Since February 2009, RCDs (residual current protective devices) have been prescribed for receptacle circuits of up to 20 A in interior rooms and of up to 32 A in outside areas which are used by electrotechnical non-professionals.



Note: The photovoltaic power supply inverters without transformers meet the fault protection requirements according to DIN VDE 0100-712, IEC 60364-7-712:2002 and CEI 64-8/7 and can be operated with a type A residual-current circuit breaker without any functional impairment of the protection or the inverter.  
The rated leakage current should be at least 100 mA per inverter.

## 4.12 PV- Generator DC Connection



**CAUTION**

Before connecting the PV strings, connect the inverter to the power supply network and to the ground bolt to ensure that the device is safely connected to the protective conductor.

Connect the PV strings to the inverter only in the de-energized state, optimally in the dark because that is when the PV strings are inactive.

The protective conductor must be connected to the housing separately from and in addition to the power supply connection.



**WARNING**

Live PV strings can be under lethal voltages.

⇒ Before connecting the PV strings, verify that the open circuit voltage does not exceed 50 V.

- The DC connection is effected with MC4-plugs and sockets. Ensure that you use DC connectors which are suitable for the particular cable diameter. If you use connectors which are not suitable for the particular cable diameter, the protection class of the device may fall below IP65.
- Whenever it is switched on, the inverter automatically checks the insulation of the PV generator. If the insulation is defective, the inverter switches off automatically. In this case, it is absolutely mandatory that the insulation fault of the PV generator be repaired before the PV generator is connected to the inverter.
- Be absolutely sure to verify proper polarity when connecting the PV strings. Any inappropriate connection of individual strings may damage the module strings. The inverter is protected by an integrated polarity reversal protection diode. Protect the connectors such that they cannot be pulled off inadvertently.
- Close unused connectors with plugs. If you fail to do this, the protection class of the device may fall below IP65.
- The connection has to be strictly done according to chapter **Fehler! Verweisquelle konnte nicht gefunden werden.** of the operating instructions. By non-observance the dc-disconnector can be destroyed.

## 4.13 DC Connecting Line

Please note the following information (plug type, cross section) regarding the DC power cable.

Denomination	Type	Item No. MultiContact	Diameter wire insulation in mm	Cable cross section in mm <sup>2</sup>
Connector plug	PV-KST4/6I-UR	32.0015P0001	3 - 6	4 - 6
Connector plug	PV-KST4/6II-UR	32.0017P0001	5,5 - 9	4 - 6
Connector socket	PV-KBT4/6I-UR	32.0014P0001	3 - 6	4 - 6
Connector socket	PV-KBT4/6II-UR	32.0016P0001	5,5 - 9	4 - 6

To attach the crimp contacts on the site, you might acquire the pliers, type PV-CZM -19100 by MultiContact.



Note: In order to ensure the degree of protection IP65, plug connectors and power supply connection cable must be matched to each other and all unused connectors shall be fitted with blanking plugs. We suggest to use only original components of MultiContact! Please take notice of the instruction sheet of MultiContact!

### 4.14 Interface Port RS485

RS485 OUT		RS485 IN	
Pin 1	Bus termination+	Pin 1	Reference +
Pin 2	RS485+ OUT	Pin 2	RS485+ IN
Pin 3	RS485- OUT	Pin 3	RS485- IN
Pin 4	Bus termination –	Pin 4	Reference –

- Bus termination (wire jumper)

The RS485 interface supports the USS protocol (Universal Serial interface protocol) which can be used for transmission of data, for example, to a data logger of a remote monitoring system.

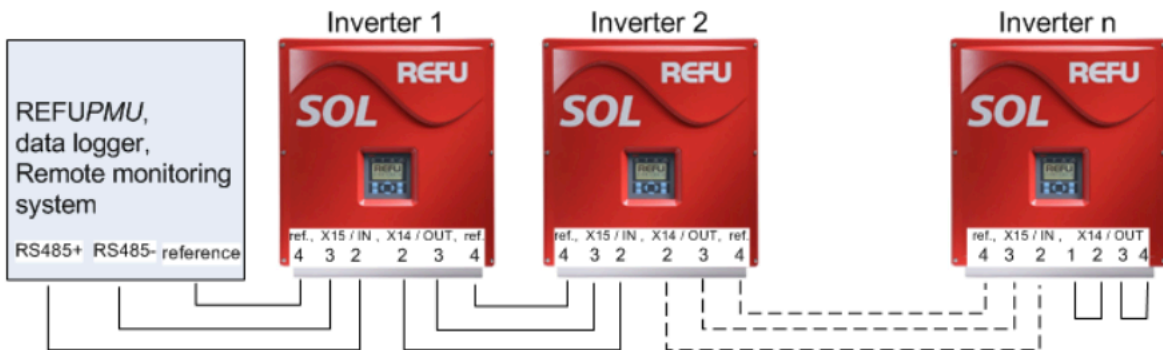

Figure No. 13 Standard interface connection

When using this interface, please note that each device using the bus requires a unique address. Bus termination is made by means of wire bridges on X14 to the last bus user (inverter “n”).

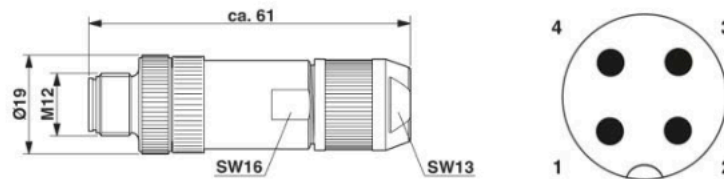

Figure No. 14 Connector M12 x 1 straight, shielded;  
pole arrangement: male M12, 4 pins, A-coded, view of male connector side



Note: The RS485 interface connecting cables must be shielded. The shield must be applied according to the plug manufacturer's specifications. The outer diameter of the connecting cable can be max. 8mm.

Optionally, 2 x RS485 connectors (IN / OUT) 4-pin Type M12 MS SACC-4SC SH can be used. The RS-485 connectors can be separately ordered from REFUSOL GmbH under the part no. 0033270.

---

- **Ethernet**

Please use an Ethernet cable with S/FTP design (shielded foiled twisted pair).



Note: Optionally, an Ethernet connector from Phoenix Contact Type VS-08-RJ45-5-Q / IP67 can be used. The Ethernet plug can be separately ordered from REFUSOL GmbH. under the part number 0028943.

---

## 5 Commissioning

Before commissioning the inverter, be sure the following steps have been completed:

- Confirm the correct power supply connection
- Confirm the correct connection of PV strings
- Confirm that connectors are protected such that they cannot be pulled off inadvertently



VORSICHT

### Risk of electric shock!

- Before switching on the device, check whether the connectors are securely fitted (locked).
- Do not pull off the connectors of the PV generator before you have met the following requirements:
  - Set the DC isolator on the inverter to "OFF".
  - Check whether the DC cables of the PV generator are de-energized.
  - Enable the power supply line and protect the voltage supply against being reactivated.



CAUTION

### Risk of electric shock and fire caused by high leakage current!

Before connecting the device to the supply circuit, establish a ground connection.

### 5.1 Turn on the Device

- Verify that the device is connected to line voltage. If not, insert the external power fuse or turn on the circuit breaker.
- Set the DC isolating switch on the inverter to the ON position.  
The inverter will not start running with connected PV field before the DC isolator is switched on.



Note: The control panel is only active with activated DC voltage. The control panel, including its status indicators, display and operator keys, is only active with activated DC voltage because the electronics of the inverter is exclusively supplied from the DC side.

## 5.2 Setting the Country Code and the Menu Language

The country code defines the country-specific network monitoring parameters. The menu language is automatically set when the country code is selected. Thereafter, the menu language can be selected as desired at any time, independent of the country code set in the menu.

The country code is not set on delivery.



**CAUTION**

### The selected country code can only be changed by Service personnel!

After having set and confirmed the country code, you cannot change it yourself any longer.

This is also applicable to devices which are or were in operation. According to a new rule, the country code can now only be changed by Service personnel.



**CAUTION**

### Cancellation of the operating licence!

If the inverter is operated with a wrong country code, the electric supply company may cancel the operation licence.

It is not allowed to put the inverter into operation before the overall system complies with the national rules and safety regulation of the application.



Note: We do not assume any liability for any negative consequences of an incorrectly set country code!

### Setting the country code

Immediately after the DC voltage has been activated, the following window appears on the screen, requesting you to set the country code. You can select the country desired from the list. The term "country code" as such is not displayed in the menu. The display will be illuminated after you have pressed the first key.

Belgie  
 Česko  
**Deutschland ENS**  
 Deutschland MSR  
 España RD1663  
 España RD661  
 France

**ENS** => Setting for systems that feed into the low voltage grid

**MSR** => Setting for systems that feed into the medium voltage grid

In case of ambiguity, contact the local utility.

Greece (Continent)  
 Greek Islands  
 Italia  
 Italien Option  
 South Korea  
 Portugal  
 Slovenija

1. Use the “▲” and “▼” keys to select the country code which is specific for your country and your location.

- When you select the country code, you automatically select the menu language at the same time.

- The menu language can be changed in the menu at any time.

2. Press “↵” to confirm.



Note: If network conditions are difficult at a location in Italy, you can select the “Italia Option” setting, provided this has been specifically approved by ENEL.

### Accepting the country code

The display will show a safety prompt asking you whether you wish to accept the country code. After having accepted the country code, it is no longer possible to change it.

Accept ?  
 Yes = Enter  
 No = Esc

1. Confirm the country code only if you are absolutely sure.

- If you are not sure, press "ESC" to cancel your selection. In this case, you cannot put the device into operation and using the menu is not possible any longer.

- If you wish to accept the country code, press “↵” to confirm.

### Changing the menu language

The language selected does not affect the country code in any way. Proceed as follows to change the menu language:



1. Press “F1” to open the menu.

2. Use the “▼” and “▲” keys to select the forth menu item: Configuration.

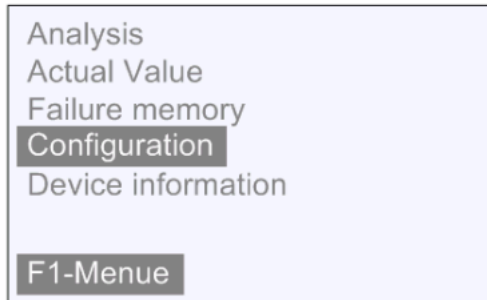



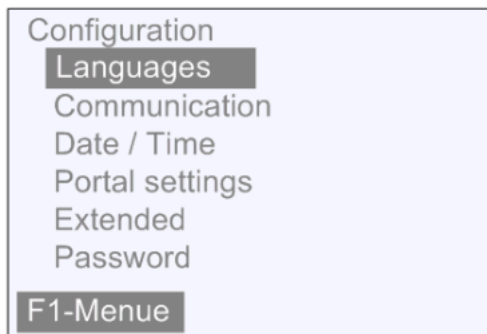

3. Press “” to confirm.

4. Use the “” and “” keys to select the first menu item: Languages.



5. Press “” to confirm.

6. Use the “” and “” keys to select the desired menu language.

7. Press “” to confirm.

The menu switches to the language selected.

The display will be empty at first.

8. Press “ESC” to return to the menu.

### 5.3 Activating the Device

- Verify that the device is connected to line voltage. If not, insert the external power fuse or turn on the circuit breaker.
- Set the DC isolating switch on the inverter to the ON position.

Provided that the solar modules are exposed to sufficient sunlight and that there are no errors or failures, the device undergoes the following sequence of operations which you can follow on the display of the control panel:

- Self-test:
  - ⇒ All status LEDs are lit for approx. 6 seconds
- The initialization cycle is started:
  - ⇒ The "Ready" status LED is flashing
  - Display:
    - ⇒ PAC            Feed power in watts (W)
    - ⇒ UAC            Line voltage in volts (V)
    - ⇒ UDC            Solar cell voltage in volts (V)

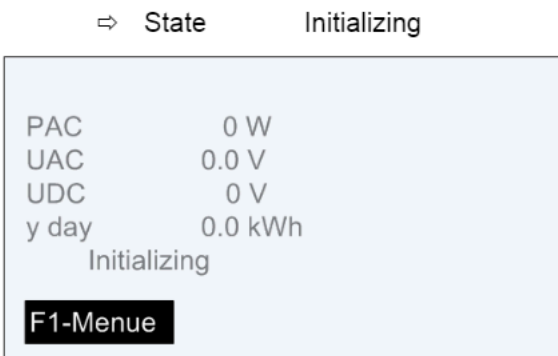

Figure No. 15      Initializing display

- Initializing has been completed:
  - ⇒ The "READY" status LED emits steady light
  - Display:
    - ⇒ PAC            Feed power in watts (W)
    - ⇒ UAC            Line voltage in volts (V)
    - ⇒ UDC            Solar cell voltage in volts (V)
    - ⇒ Switched off



Figure No. 16      Device activation display

- Power-up starts if the solar cell voltage is >350 volts:
  - ⇒ The "READY" status LED is lights, the "ON" status LED is flashing
- Display:
  - ⇒ Pac            Feed power in watts (W)
  - ⇒ Uac            Line voltage in volts (V)
  - ⇒ UDC            Solar cell voltage in volts (V)
  - ⇒ Activating
  - ⇒ This process can take up to one hour while the device is commissioned; during normal operation, it takes up to 3 minutes.
- Feed mode:
  - ⇒ The "ON" status LED emits steady light; the "READY" status LED turns dark.
  - Display

- ⇒ PAC            Feed power in watts (W)
- ⇒ UAC            Line voltage in volts (V)
- ⇒ UDC            Solar cell voltage in volts (V)
- ⇒ Y DAY        Yield of the day in kWh
- ⇒ Operation

- Check time:

If the electronic system was disconnected from the supply voltage for a longer period (approx. 2-3 weeks) incorrect time setting is possible. Therefore, before switching ON the inverter and if the PV-Panels are covered with snow for long period of time, you have to control the time and readjust if necessary as follows:

- For this reason, the time must be checked and reset if necessary before switching on:
- Press F1 key to open menu.
- Use ▼ and ⬅ / ➡ arrow keys to select the „Configuration“ item.
- Use ▼ arrow key to select menu item to set “time/date” ⬅ / ➡
- Use ➡ ⬅ arrow keys for successive setting of day, month, year hour, minute, and second.
- Press ⬅ key to confirm.

## 5.4 Navigation on the Control Panel

Navigation display:

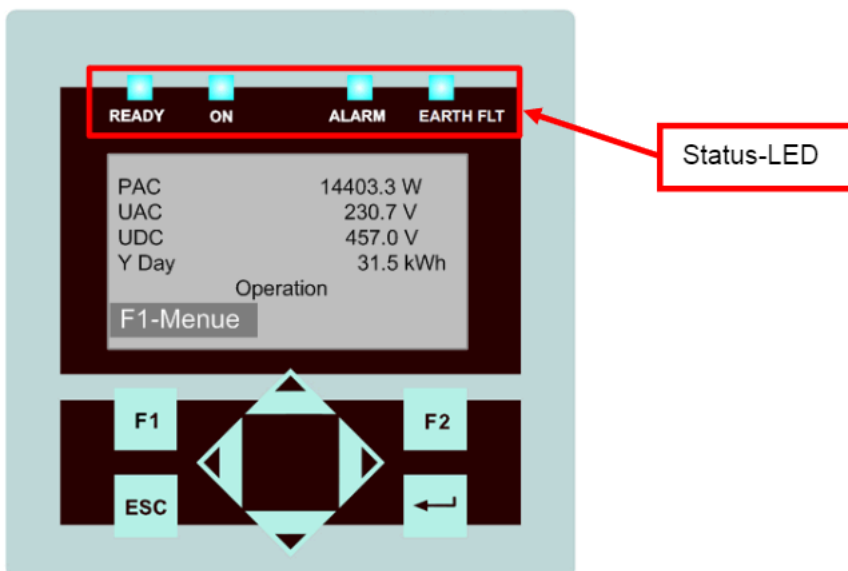

Figure No. 17      Display Navigation

F1:      Display the menu

◀▶:    Function in the menu: navigation through the menu level (previous menu, next menu)

Function while parameters are edited: digit to the left, digit to the right (decade jump)

- ▲▼: Select the menu level (level up, level down)
- ESC: Acknowledge failures and exit from menu-level, exit from input level without acknowledge
- ↵: Confirm the selected menu and entered data

## 5.5 Password Entry

For the configuration and parameterization often the customer password **72555** is required!

Password entry as follow:

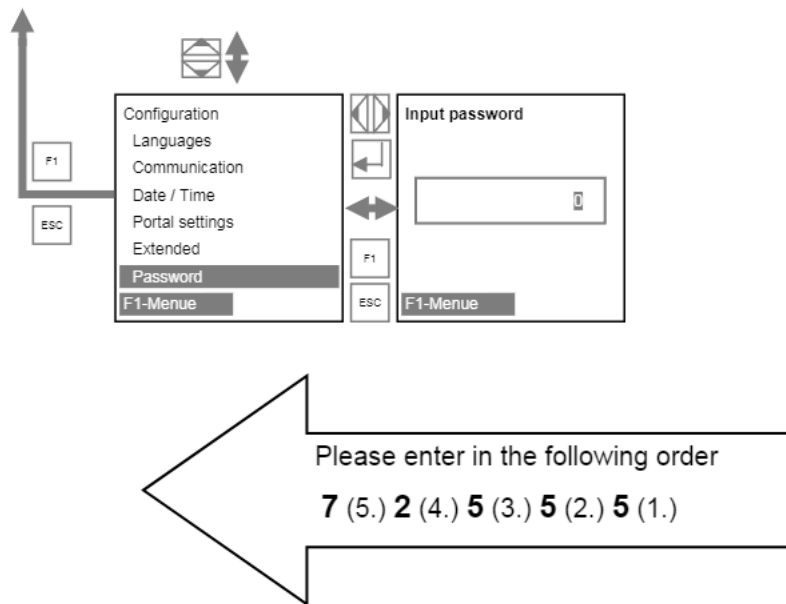

### Basic screen display:

PAC	14493 W
UAC	230.9 V
UDC	458 V
y day	31.5 kWh
Operation	
<b>F1-Menue</b>	

Figure No. 18 Operating mode display

PAC = current feed power

UAC = line voltage

UDC = solar cell voltage in volts (V)

y day = yield of the day in kWh

**Graphical display:**

Press the ◀ arrow key once to display the development of the day's feed power.

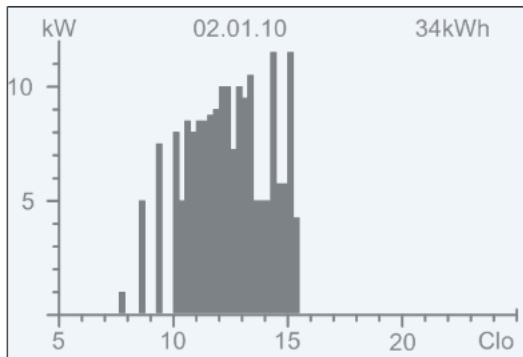

Figure No. 19 "Today's" feed power display

Press the ▼ arrow key to display the development of the previous days.

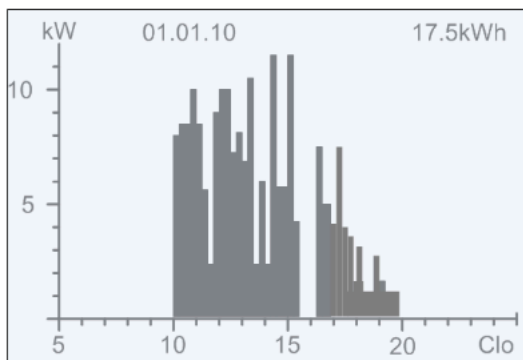

Figure No. 20 "Yesterday's" feed power display

Press the ESC key to return to the basic screen display.

**Yield data display:**

Press the ▶ arrow key to display the current yield data and the operating hours having currently elapsed.

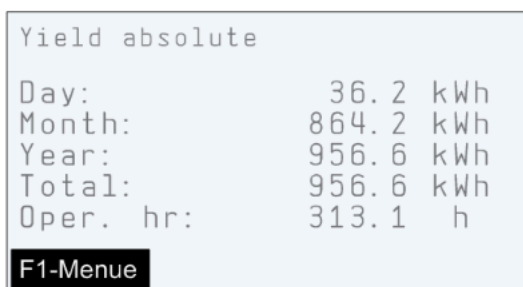

Figure No. 21 Yield data absolute

**Standardized yield data display:**

Press the ► arrow key, then the ▼ arrow key to display the development of standardized yield data.

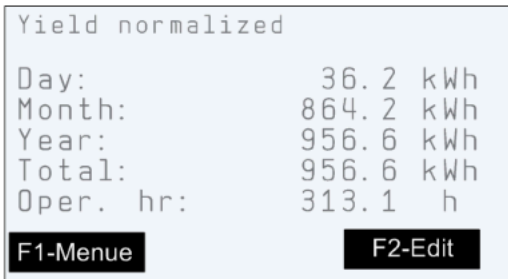

Figure No. 22 Standardized yield data display

Press the ESC key to return to the basic screen display.

**Input of standardized data:**

To obtain the standardized yield data, press the F2 key and enter the connected PV generator power under parameter P1155 as follows:

- keys: ◀▶: Press the ◀ key => selects the digit to the left of the decimal point  
 Press the ▶ key => selects the digit to the right of the decimal point
- key ▲: Whenever you press this key, the number at the digit selected is incremented by 1.
- key ▼: Whenever you press this key, the number at the digit selected is decremented by 1.



Figure No. 23 Standardized data input display

Press the ESC key, the previous “normalized yield” level will displayed.

Press the F1 key to display the menu.

Press the ↵ to apply the set value. However, this requires that the password is correct.

## 5.6 Menu Structure

The menu structure serves as a support to change to the individual information displays and setting displays.

### Legend:

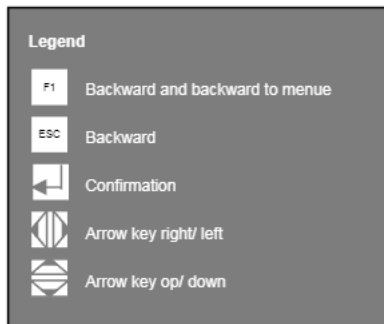

Menu guide

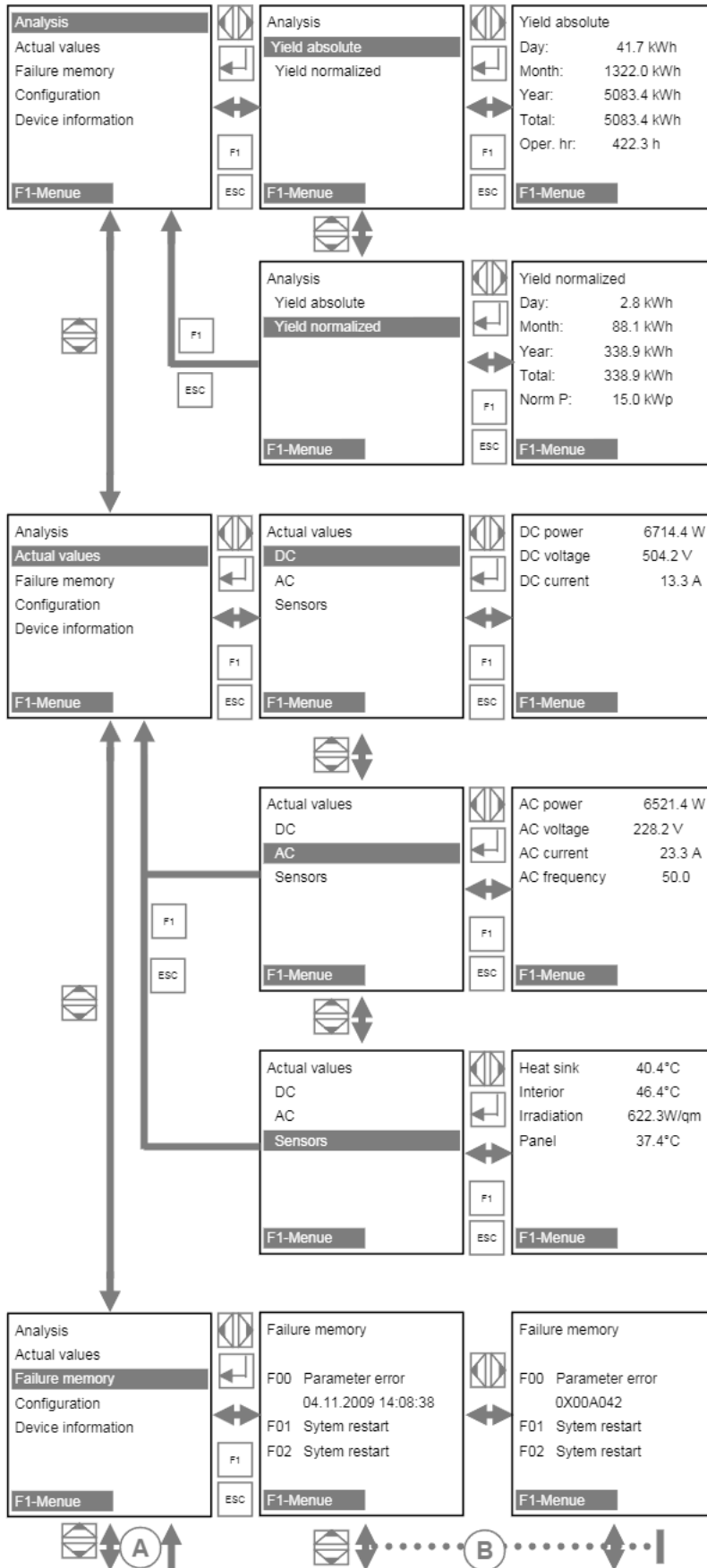



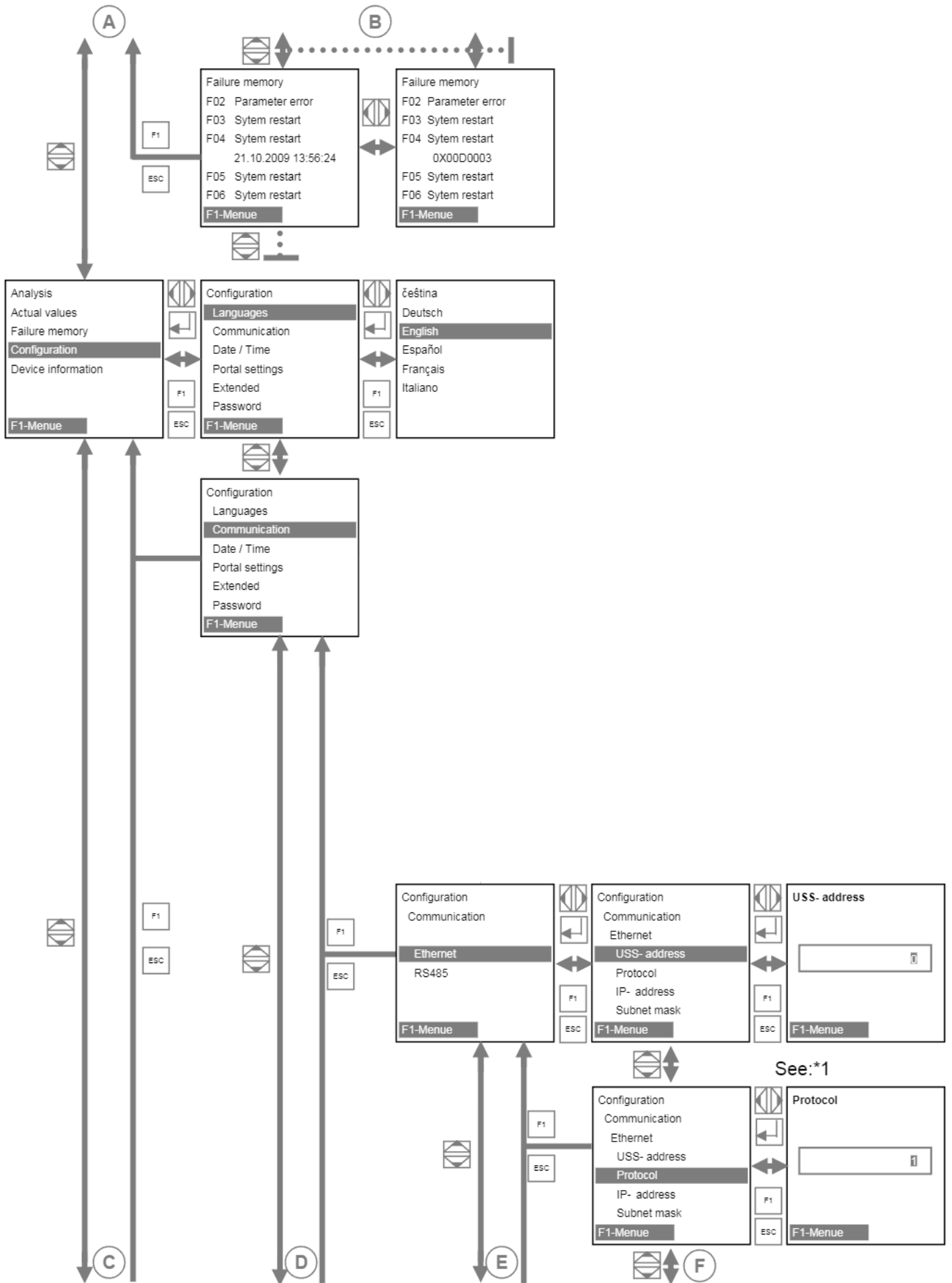

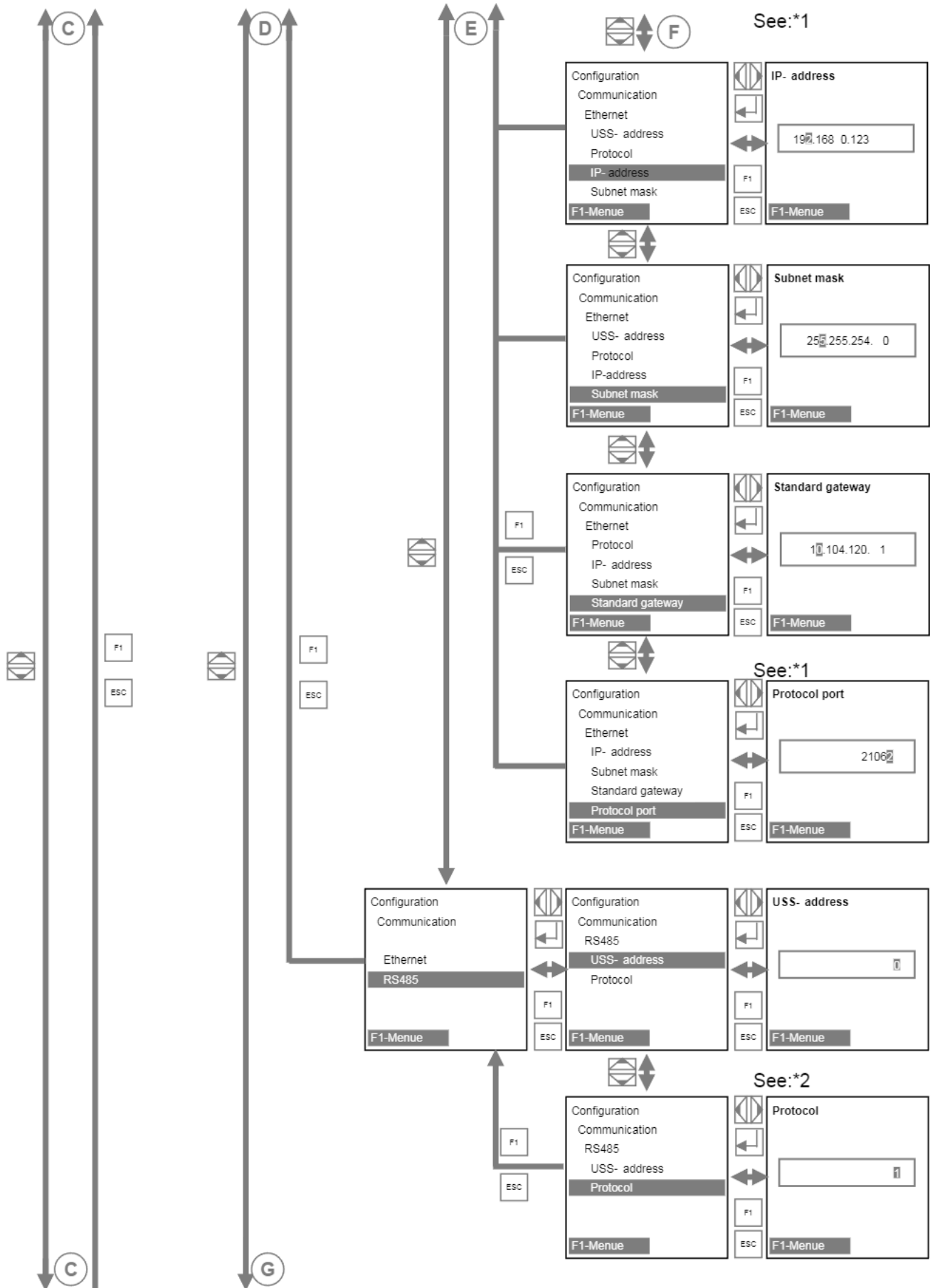

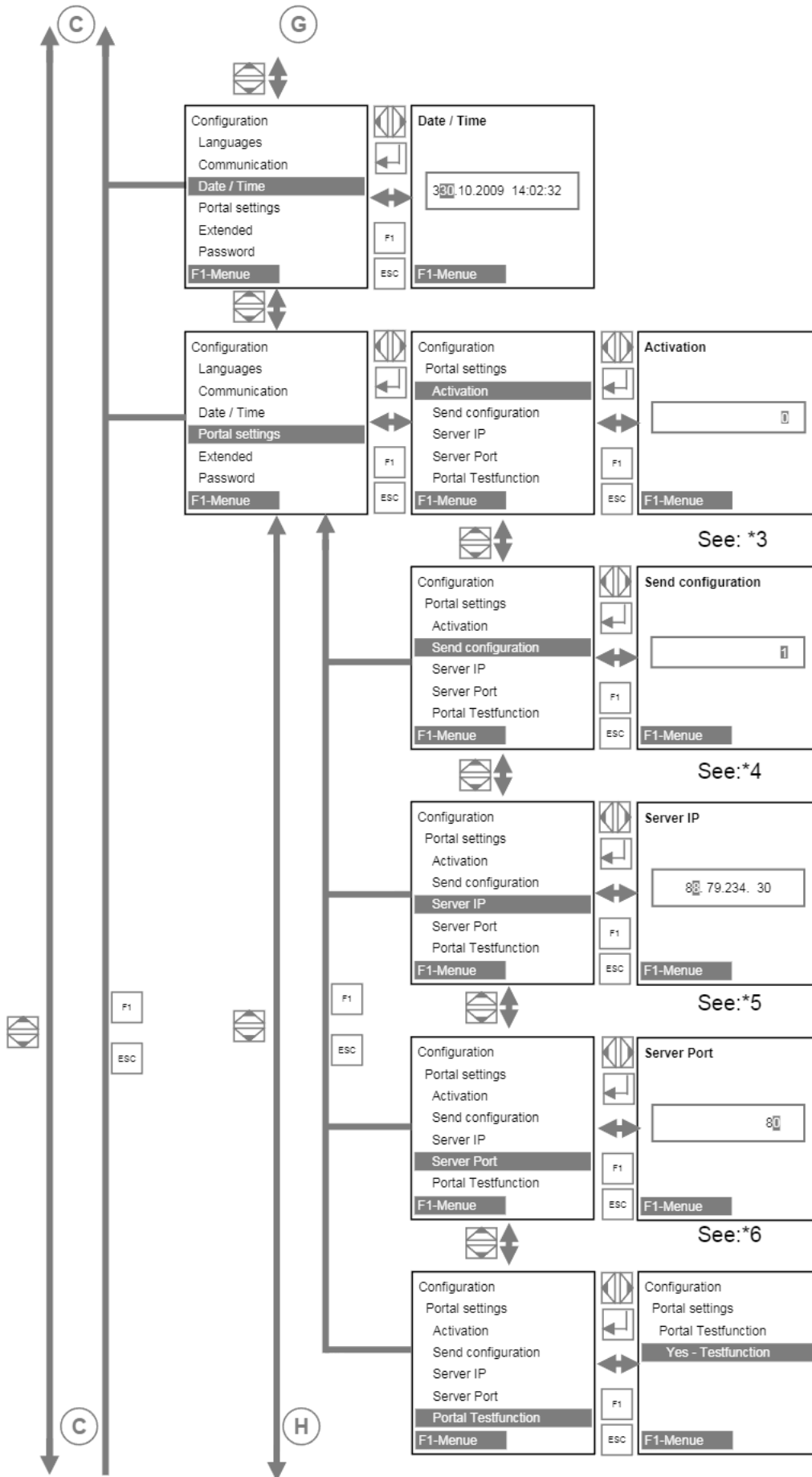

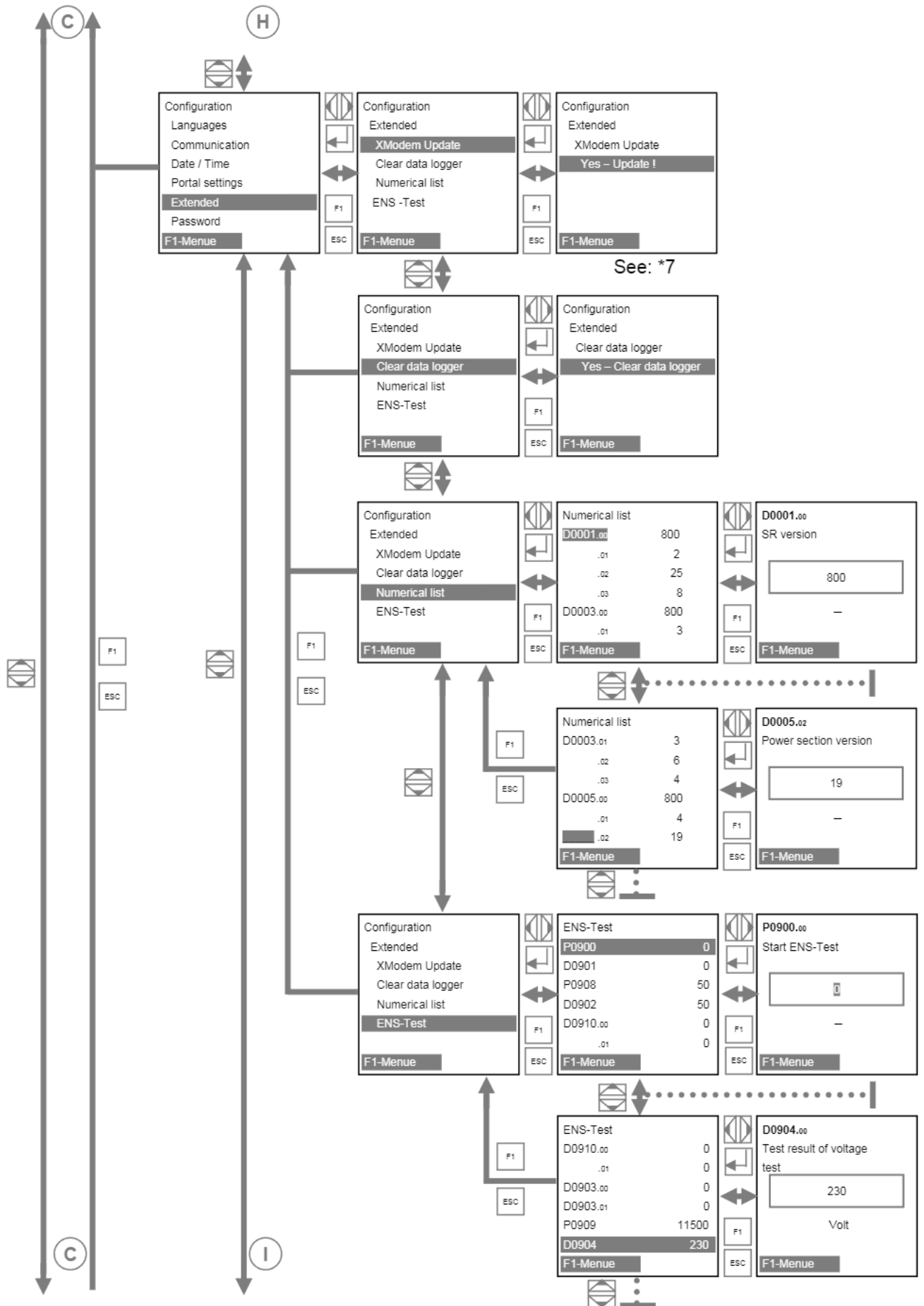

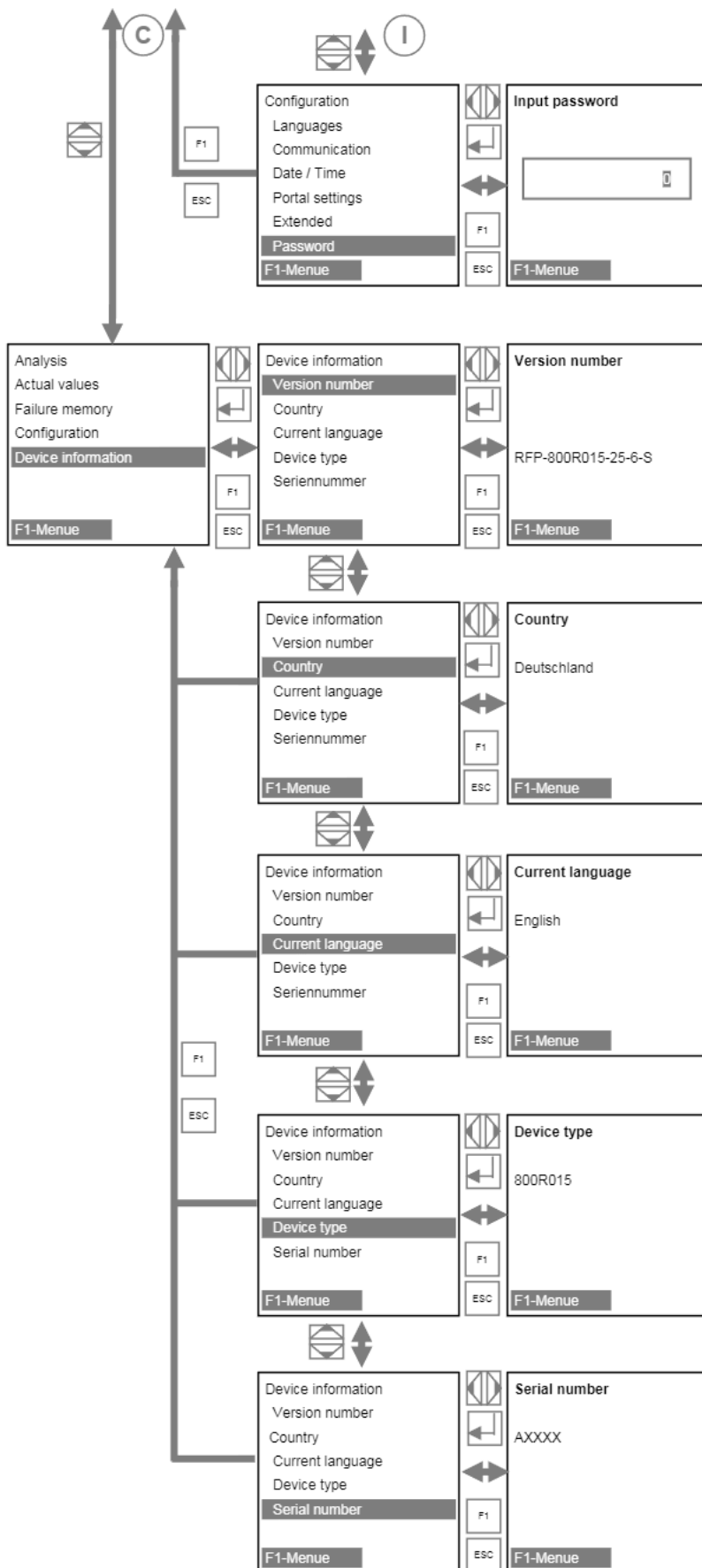

## 5.7 ENS Test

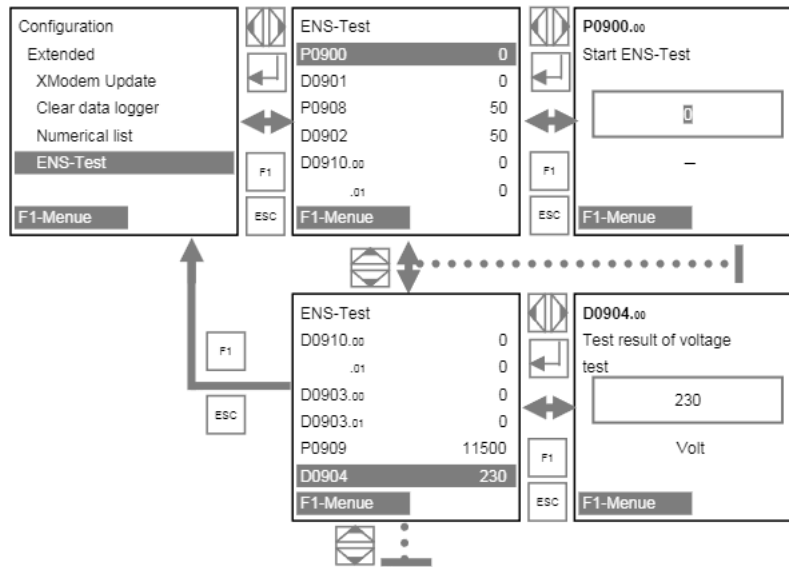

**Note:** If the ENS test is carried out while the device is disconnected from power supply, there will be no result. First restart the device.

### Carrying out the ENS Test:

- Set P0900 to "1" → starts the ENS test
- P0901 shows the progress of the ENS test
- P0908 informs about the frequency ramp (in mHz/s)
- P0902 shows the development of the simulated frequency
- P0910.00 shows the time measured until the lower frequency limit is reached
- P0910.01 shows the time measured until the upper frequency limit is reached
- P0903.00 shows the frequency value having caused turnoff at the lower limit
- P0903.01 shows the frequency value having caused turnoff at the upper limit
- P0909 informs about the voltage ramp (in mV/s)
- P0904 shows the development of the simulated voltage
- P0910.02 shows the time measured until the lower voltage limit is reached
- P0910.03 shows the time measured until the upper voltage limit is reached
- P0905.00 shows the voltage value having caused turnoff at the lower limit
- P0905.01 shows the voltage value having caused turnoff at the upper limit

### ENS test status list:

- 0 Initializing / ready for start
- 1 ... 3 Frequency test at the lower frequency limit

- 4 ... 6 Frequency test at the upper frequency limit
- 7 ... 9 Voltage test at the lower voltage limit
- 10 ... 12 Voltage test at the upper voltage limit
- 13 ENS Test completed

## 6 Configuration

### 6.1 Reduction of the power output

Proceed as follows in order to limit the power output of the inverter::

1. Enter the customer password "72555".
2. Using the F1 key, select the menu item Configurations and confirm with the key.
3. Select the sub-menu "PAC reduction" and confirm with the key.
4. Enter the inverter power output desired and confirm with the key. An input of 70, for example, means that the inverter will only deliver 70 % of its possible power output.
5. Switch off inverters with DC circuit breakers for 30-60 seconds.
6. The amended input value will be adopted when the device is switched back on again

### Input of $\cos \varphi$

The specification of  $\cos \varphi$  can be entered in the following ways:

Using the F1 key, select the menu item Configuration and confirm with the key.

From the Configuration menu, select the sub-menu "Expanded" and confirm with the key.

Within the menu item "Expanded", select the sub-item "Numerical list" and confirm with the key.

Enter parameter "1164" using the arrow keys and confirm with the key.

⇒ The list of input options for  $\cos \varphi$  will be displayed.

Parameter 1166: Input of the fixed value for  $\cos \varphi$  as angle.

Parameter 1167: Squint angle variable. The function requires the REFUpmu option.

Parameter 1168: Squint angle via P characteristic curve by means of 10 values in degree specification. Parameters 1168.00 to 1168.10.

Parameter 1169: Squint angle via U characteristic curve by means of 10 values in degree specification parameters 1169.00 to 1169.10

### 6.2 Communication via Ethernet

USS address:

Is factory-set and cannot be changed.

Protocol:

Input 0 or 1

0 = RTP protocol

1 = USS and RTP protocol

Protocol port:

Input 1024...65535; default setting 21062.

The port number is required for communication via Ethernet.

### 6.3 Communication via RS485

USS – adress:

Input 1 – 31



This address is required for communicating with the inverter via RS485

Note:

If you change this parameter (address) and wish to save it, you must restart REFUso®!  
The new address will only be active thereafter.

Protocol polling via Ethernet:

Input 1, 2 and 3

1: USS and RTP protocol

2: Solar data systems (old SolarLog® firmware)

3: MeteoControl®

## 6.4 Portal monitoring

Activation 0 or 1

0 = Portal monitoring not activ

1 = Portal monitoring activ

For using the portal moitoring REFU/og the portal monitoring have to be set activ.

## 6.5 Sending Config

Activation 0 or 1

0 = no Config data in the waiting queue

1 = Config is sent.

## 6.6 Server IP

Display of IP adress

## 6.7 Server port

Display of the port number of the web server.

## 6.8 Portal test function

Input: "yes"

A data package is sent to the web server (portal).

There is no feedback!

Please contact the Service to learn whether the data package was sent successfully.

## 7 Troubleshooting

### 7.1 Self-test Error Messages

After the initialization routine, the system runs through a self-test. The individual parts of the system, such as firmware and dataset, are checked and data is read in from the power control board. If an error continues to be ascertained, possible Remedial measures must be taken according to the type of error.

### 7.2 Transient Failure

In certain operating states the inverter goes temporarily offline.

Unlike failures, "transient failures" are automatically acknowledged by the inverter which attempts to restart once the error no longer exists.

A transient failure is indicated by the red LED alarm on the control panel flashing and remains stored in the error memory even in the event of a power failure. See the Faults section.

### 7.3 Faults

Permanently programmed and parameterizable limit values are continuously monitored during on-going operation. In order to be protected, the inverter power section is isolated from voltage supply if a limit value is exceeded or if a failure occurs. However, the DC and AC voltages may still be available. The corresponding fault message appears in the display.

The fault is indicated on the control panel by the red "Alarm" LED emitting steady light.

Fault messages are stored in the fault memory, where they will remain even in the event of a power failure. The fault memory can be called up via the display. The last 100 faults are recorded in the fault memory. The latest fault is kept at memory location S0, the oldest at S100. A new fault is always stored to memory location S0. When this happens, any fault already at memory location S100 will be lost.

### 7.4 Fault Acknowledgement

After shutdown due to a fault, the device remains locked against reactivation until the fault is acknowledged. It is not possible to acknowledge the fault while the cause of the fault still exists. The fault can only be acknowledged after the cause of the fault has been eliminated.

- ⇒ To acknowledge the fault message, press the ESC key or turn the inverter off with the DC switch and wait min. 30 seconds to turn the inverter ON again.

## 7.5 List of Fault Messages

Error code	Error message	Description	Action
0X30002	Parameter error 1	A defective parameter file was found when the special functions were initialised.	Please arrange for Service to perform an update.
0X30005	Parameter error 2		
0X30006	Parameter error 3		
0X40001	Internal communicatn.	Timeout between control and regulation unit card and power section	If problem occurs repeatedly, contact Service.
0X40010	System error 1	Operating system crash	
0X50000	System error 2	Initialisation has failed.	Restart inverter. If this does not rectify the error, contact Service.
0X60001	Incorrect time	Inverter is feeding in with incorrect time as real-time clock has not been initialised.	Set correct time.
0X70000	Update registration	An additional update could not be registered.	Wait until the current update is complete.
0X70001	Update in progress	An update is already in progress.	Wait until the update is complete.
0X80001	Incorrect time	Initialisation of real-time clock has failed. This prevents data logger from functioning.	Set correct time.
0X90001	System restart	The inverter has been restarted.	This text is displayed for information purposes only.
090002	Program CRC error	Checksums do not correspond.	Please arrange for Service to perform an update
090004	RAM error 1	RAM error detected in a safety-critical variable	
090005	MMU exception	Program memory protection fault	
0A0001	Regulator voltage 1	Regulation error in positive boost converter	Wait for the regulator to become stable again. If this takes more than 2–3h, please contact Service.
0A0002	Regulator voltage 2	Regulation error in negative boost converter	
0A0003	Regulator voltage 3	Asymmetry low: Difference between the two solar voltages is too high.	If problem occurs once only: wait for the regulator to become stable again. If problem occurs repeatedly: please contact Service.
0A0004	Regulator voltage 4	Asymmetry high: Difference between the two boosted DC link voltages is too high	
0A0005	Regulator voltage 5	The positively boosted DC link has dropped below the mains peak value	
0A0006	Regulator voltage 6	The negatively boosted DC link has dropped below the mains peak value.	
0A0007	Regulator voltage 7	The positive solar voltage has dropped below the limit value.	
0A0008	Regulator voltage 8	The positive solar voltage is too high.	
0A0009	Regulator voltage 9	The negative solar voltage has dropped below the limit value.	

Error code	Error message	Description	Action
0A000A	Regulator voltage 10	The negative solar voltage is too high.	
0A000B	Regulator voltage 11	The positively boosted DC link voltage is too high.	
0A000C	Regulator voltage 12	The negatively boosted DC link voltage is too high.	
0A000D	Grid overvoltage	A grid overvoltage has been detected.	If the inverter is detecting a grid overvoltage: check line voltages (with a true RMS measurement device). If you consider the line voltages to be in order, contact Service.
0A000E	Grid undervoltage	Grid undervoltage has been detected. Grid voltage dip	As long as the inverter is detecting a grid undervoltage: check line voltages (with a true RMS measurement device). As long as you consider the line voltages to be in order, contact Service.
0A000F	Grid overvlt.  2	Grid line-to-line overvoltage detected	As long as the inverter is detecting a grid line-to-line overvoltage: check the line-to-line voltages (with a true RMS measurement device). As long as you consider line-to-line voltages to be in order, contact Service.
0A0010	Grid undervlt.  2	Grid line-to-line undervoltage detected	
0A0011	Grid frequency FLL	A grid error has been detected (FLL).	Check grid frequency and grid instantaneous voltage. Service, if the grid frequency is within the normal range.
0A0012	Overfrequency	The grid frequency has exceeded the limit value.	As long as the inverter is detecting an overfrequency: check the frequency of the phases. As long as you consider the frequencies to be in order, contact Service.
0A0013	PM isolation RCD CR	Control and regulation unit has detected residual current.	Check system isolation. If you consider the system isolation to be in order, contact Service
0A0014	No country code	No country code has been set, or code invalid.	Please contact Service.
0A0016	Underfrequency	The grid frequency has dropped below the limit value.	As long as the inverter is detecting underfrequency: check the frequency of the phases. As long as you consider the frequencies to be in order, contact Service.
0A0018	Voltage error max	The nominal grid voltage was below the limit value of the voltage average monitor for too long.	As long as the inverter is detecting the voltage error max: monitor line voltages (analyse grid). As long as you consider the line voltages to be in order, contact Service
0A0019	Voltage error min	The nominal grid voltage was above the limit value of the voltage average monitor for too long.	As long as the inverter is detecting the voltage error min: monitor line voltages (analyse grid). As long as you consider the line voltages to be in order, contact Service.

Error code	Error message	Description	Action
0A0100	Fault message PS	Fault message from power section	Additional faults with the same time stamp are present. See fault memory.
0A0102	Overtemperature PS 1	Cooler overtemperature (right)	Check temperature of direct surroundings and reduce this as required.
0A0103	Overtemperature PS 2	Interior overtemperature (left)	Check temperature of direct surroundings and reduce this as required.
0A0104	Overtemperature PS 3	Interior overtemperature (right)	
0A0105	Overtemperature PS 4	Cooler overtemperature (left)	
0A0106	Supply voltage PS	Supply voltage at the power section is too low.	Please contact Service.
0A0108	Grid frequency PS	Power section has detected under/overfrequency	As long as the inverter is detecting a PS grid frequency: check the frequency of the phases. As long as you consider the frequencies to be in order, contact Service
0A0109	Grid overvoltage PS	The power section has detected a grid overvoltage.	As long as the inverter is detecting a grid overvoltage: check line voltages (with a true RMS measurement device). As long as you consider the line voltages to be in order, contact Service.
0A010A	Grid undervoltage PS	The power section has detected a grid undervoltage.	As long as the inverter is detecting a grid undervoltage: check line voltages (with a true RMS measurement device). As long as you consider the line voltages to be in order, contact Service.
0A010C	PM isolation PS	The power section has detected a grid undervoltage.	Check system isolation. If you consider the isolation resistance to be in order, contact Service.
0A010D	RCD fault	The power section has detected residual current. Isolation error during operation.	
0A010E	Device fault PS	Power section hardware shutdown	Note: When did the error occur (precisely: day, kW output, time).
0A0110	Solar voltage PS 1	Power section overvoltage shutdown in positive DC link	Do nothing. The inverter will acknowledge the error automatically.
0A0111	Solar voltage PS 2	Power section overvoltage shutdown in negative DC link	If problem occurs repeatedly, contact Service.
0A0114	PM isolation RCD PS	The isolation impedance of the photovoltaic module is too low	Check system isolation. If you consider the system isolation to be in order, contact Service.
0A0115	RCD warning	The power section has detected residual current during operation.	
0A0117	Isolation test unit	DC discharge is taking too long.	Please contact Service.
0A0118	Voltage offset PS	Offset adjustment values between power section and control and regulation unit divergent	
0A0119	Current transdcr. PS	Current transducer could not detect any current flow.	Do nothing. The inverter will acknowledge the error automatically.
0A011A	Activation PS 1	DC discharge is taking too long.	If problem occurs repeatedly, contact Service.

Error code	Error message	Description	Action
0A011B	Activation PS 2	DC link voltage drop during activation	
0A011C	Activation PS 3	Target value for balancing is invalid.	
0A011D	Activation PS 4	Balancing has failed	Please contact Service.
0A011E	Activation PS 5	Uploading of DC links has failed.	
0A011F	Parameter error PS 5	Faulty reading or writing process in power section memory	<p>1.) Switch off device with DC disconnecter.</p> <p>2.) Wait until the display has turned off completely.</p> <p>3.) Switch on device with DC disconnecter.</p> <p>If this does not rectify the error, contact Service.</p>
0A0120	Communication PS	Communication malfunction between power section and control and regulation unit	Do nothing. The inverter will acknowledge the error automatically. If problem occurs repeatedly, contact Service.
0A0130	PS elements	Faulty configuration of elements for the power section	Please contact Service.
0A0131	Combine relay	Switching the combine relay has failed.	
0A200D	Overtemperature 6	Device temperature too high	Do nothing. The inverter will acknowledge the error automatically. If problem occurs repeatedly, contact Service
0B0001	System 1	Error in error management system	Please contact Service.
0B0002	System 2	Error memory is full.	
0B0003	System 3	Error memory is full	
0D0001	System error	A connection to the power section could not be established during the firmware update.	<p>1.) Switch off device with DC disconnecter.</p> <p>2.) Wait until the display has turned off completely.</p> <p>3.) Switch on device with DC disconnecter.</p> <p>If this does not rectify the error, contact Service.</p>

Error code	Error message	Description	Action
0D0002	PS bootloader	Power section bootloader faulty	<p>One of the power section's two bootloaders is faulty.</p> <p>This text is displayed for information purposes only. The inverter will continue to function.</p> <p>Please contact Service and arrange for a firmware update to be performed.</p>
0D0003	System restart	System has been restarted to enable a firmware update to be performed	This text is displayed for information purposes only. If an update is not performed, please contact Service
100001	Ethernet connectn. 1	A connection to the ethernet could not be established	Inspect ethernet connection: check IP address, subnet mask, server address and server port
100002	Ethernet connectn. 2	Loss of ethernet connection	Check ethernet connection
100003	Ethernet connectn. 3	No 100Mbit/s ethernet connection is available	<p>A 100Mbit/s ethernet connection is required.</p> <p>Check that your network is transmitting at 100Mbit/s</p>

## 8 Options

### 8.1 Power Plug

Optionally, you can also order a larger connector housing with M32 cable gland that allows you to connect a 5 x 10 mm<sup>2</sup> flexible power supply line.

Designation	REFUso/ GmbH part no.
VC-AL-T3-Z-M32-S-PLOMB	0029939

### 8.2 Radiation and temperature Sensor

A radiation and temperature sensor can be optionally connected for recording the solar radiation incidence and the module temperature. We recommend using the type Si-13TC-T-K. REFU part no. 0030628. The scope of delivery of the radiation and temperature sensor includes the sensor plug. The sensor plug can also be separately ordered from REFUso/ GmbH under part no. 0030616.

The sensor comes with a 3 meter UV-resistant connecting line (5 x 0.14 mm<sup>2</sup>). The line can be extended with a 5 x 0.25 mm<sup>2</sup> shielded line, max. 100m.

More information about the technical data of the sensor you will find in chapter 8 technical data under [8.2](#)

Si-13TC-T-K pin assignment			REFUSOL <sup>®</sup> pin assignment: <b>Sensor</b>
Red	RD	Supply voltage (12–24 VDC)	Pin 1
Black	BK	GND	Pin 2
Orange	OG	Measurement signal for incident light (0–10 V)	Pin 3
Brown	BN	Measurement signal for temperature (0–10 V)	Pin 4
Gray	GY	Shielding	Pin 5



Note: The shield of the sensor line must be applied to PIN 2 and PIN 5!  
The outer diameter of the connecting cable can be max. 8mm.

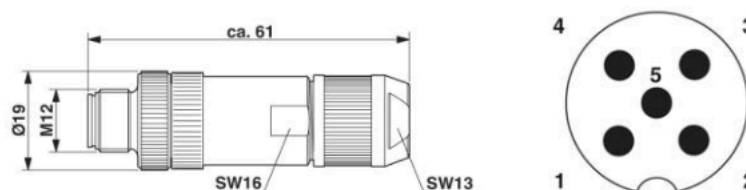

Figure No. 24 Connector M12 x 1 straight, shielded; pole arrangement: male M12, 5 pins, A-coded, view of male connector side, Phoenix nomination: SACC-M12MS-5SC SH



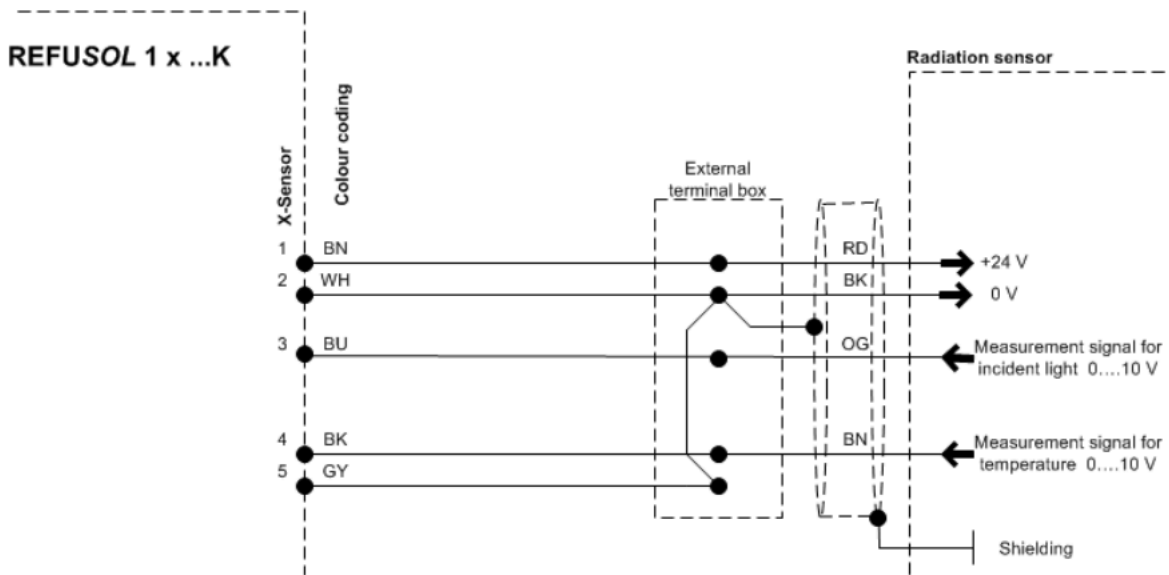

Figure No. 25 Connection of the solar radiation sensor

The data of the Si-13TC-T-K can be called up with the following parameters:

- D 1191.00 => incidence
  - 0–10 V => 0–1300 W/m<sup>2</sup>
- D 1193.00 => temperature
  - 0–10 V => –26.1° C to 90° C

This data can also be recorded in the data logger.



Note: If you do not use the temperature input, wire a jumper across PIN 4 and PIN 5. Alternatively, you can also wire the jumper to the intermediate terminal point (cable extension).

### 8.3 Remote Monitoring System

The following options are available for remote monitoring:

- REFUlog: REFUlog is a portal that has been developed by REFUsol for the purpose of monitoring and recording solar system data. For more information and details, please refer to the REFUlog. Please contact REFUsol GmbH.
- Web Log: Data logger by MeteoControl. Connection via RS485.
- SolarLog: Data logger by Solare Datensysteme. Connection via RS485.

Where MeteoControl and Solarlog are concerned, data is imported from the inverters via an RS485 interface.

For information about the configuration, please refer to the Operating Instructions of the particular data logger.

## 8.4 Instrument settings for monitoring with SolarLog® or MeteoControl®

All inverters have to be equipped with the firmware version **RTF-80xR0xx-25-x-S** or higher (available at: Menu F1/unit information/version identification/RFP ...).

The RS485 interface (RS485 IN / OUT) is standard on all REFUsol® units.

For communication via SolarLog® or Meteocontrol® each REFUsol® must be given a communication address. It is recommended to predefine the addresses continuously starting with 1 (then 2, 3, etc. to max. 31).



**Note:** The maximum number of inverters systems that can be operated at one bus is 31.

These settings visible on the inverter control panel are to be carried out as follows:

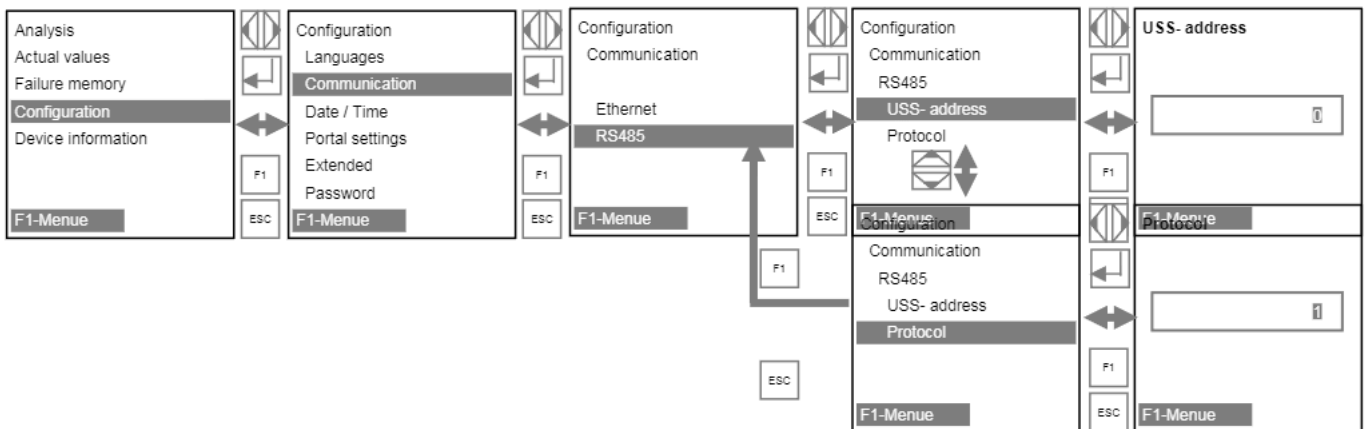

Protocol: for SolarLog® enter „2“ ,  
or for MeteoControl® enter „3“ .



**Note:** After successful entry turn the inverter off and after 1 minute turn back on!

## 8.5 Data Logger Parameters

These parameters serve as settings for the internal data logger.

Parameter number	Parameter name	Description
P450.00	Data logger enabled	<ul style="list-style-type: none"><li>Enables or disables the data logger.</li><li>0 = disabled.</li><li>1 = enabled. Data will be recorded at regular intervals.</li></ul>
P451.00	Data logger interval	<ul style="list-style-type: none"><li>Contains the time interval (60 / 300 / 600 sec) for which the data logger stores values.</li></ul>
P452.00 - 39	Data logger parameter numbers	<ul style="list-style-type: none"><li>Contains a list of all parameter numbers to be recorded. This only works in conjunction with indices (P453.x). Nonexistent parameter numbers will be ignored.</li></ul>
P453.00 - 39	Data logger indices	<ul style="list-style-type: none"><li>Contains a list of all indices assigned to the parameter numbers to be recorded. This only works in conjunction with parameter numbers (P452.x). Nonexistent parameter numbers will be ignored.</li></ul>

## 8.6 Power Cap

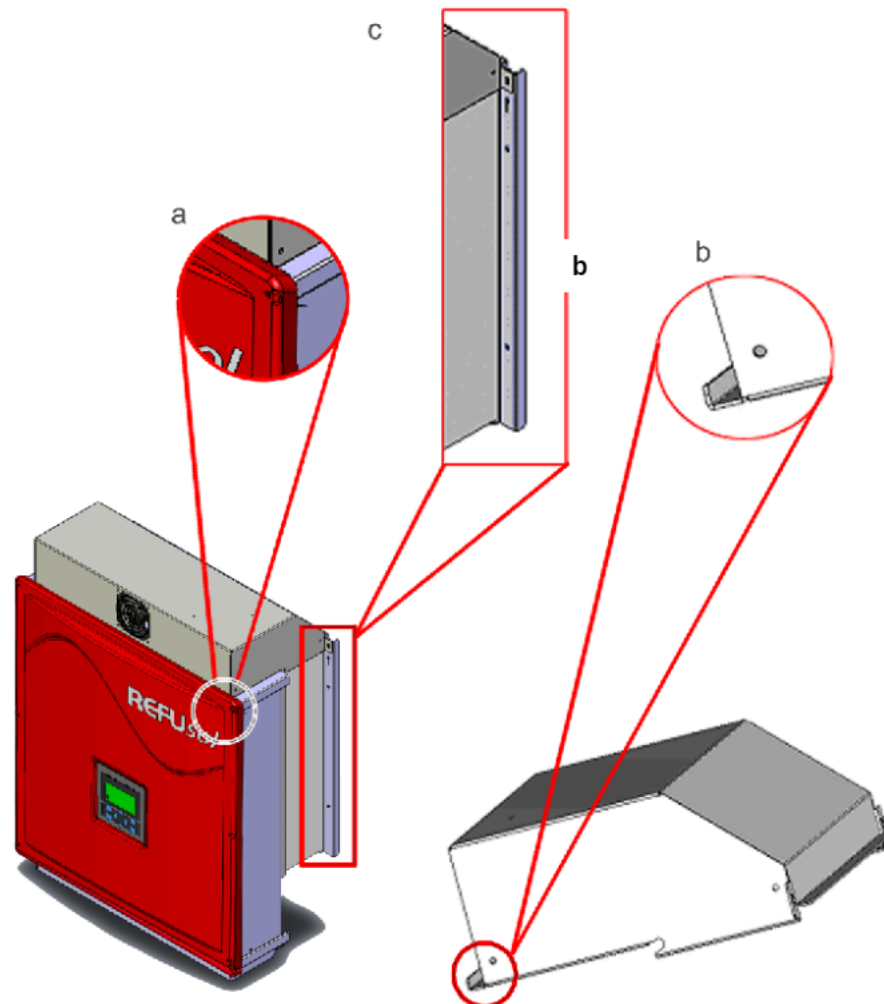

Figure No. 26 Power Cap

REFUSOL Power Cap is an additional fan module for REFUSOL<sup>®</sup> 010K to 020K, which is used if the available space requires that the REFUSOL<sup>®</sup> devices be mounted one on top of the other. Power Cap raises the permissible ambient temperature range by +5°C. The ventilation module mounts directly onto the inverter. The fold (b) must be hung into the upper edge of the front cover (a) and secured to the REFUSOL<sup>®</sup> wall-mounting bracket by means of 2 M5 screws (included in scope of delivery).

The fan inside it is powered and monitored by the inverter's sensor connector (overspeed sensing). The power supply line for the Power Cap must be attached to the wall-mounting bracket by means of the enclosed 6.5-mm polyamide mounting clips and the mounting tie. The fan motor is enclosed according to Protection Class IP 54 and has a service life of approx. 10 years.



**CAUTION**

The inverter should in no case be mounted on top of each other without a Power Cap otherwise the convection cooling will be affected!

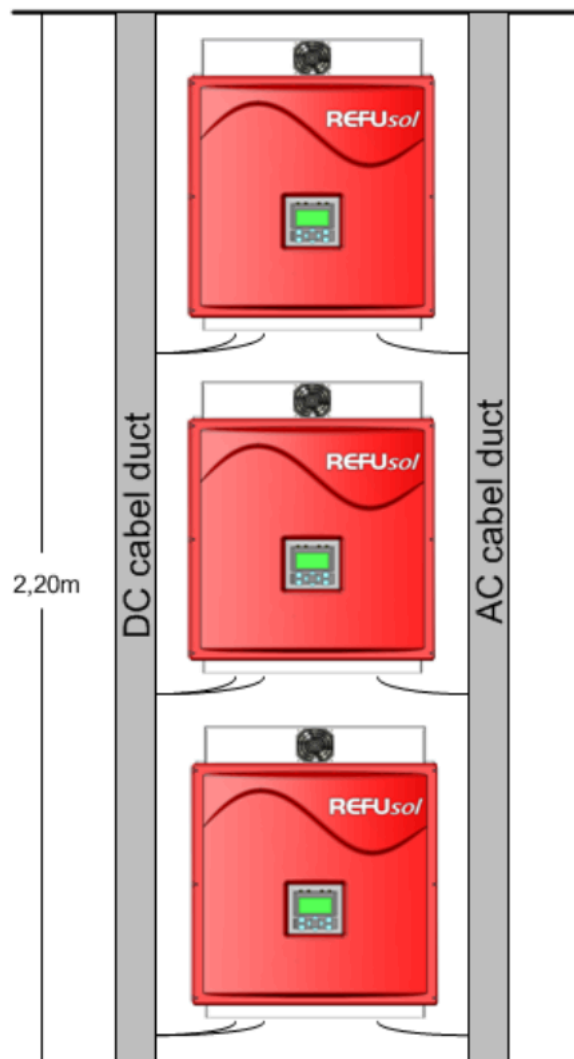

Note: If a temperature and radiation sensor is connected, a 24-V-DC power supply unit (e.g. REFUso/ part no.: 0030449; 230 VAC / 24 VDC, 18 W) must be provided to supply the Power Cap. We recommend that the power supply unit be turned on during ongoing operation of the inverter only. Implement a 230-V-AC timer switch to turn the power supply unit on and off.

## 8.7 Connecting the AC-Adaptor Electrically to the Additional Power Cap

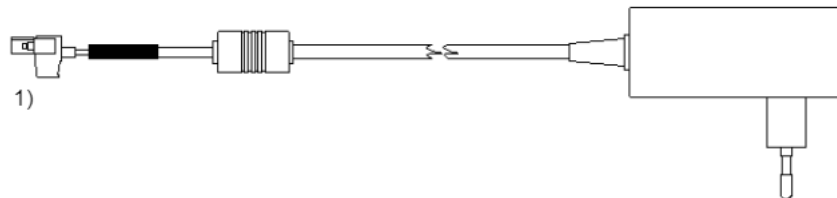

Figure No. 27 AC-adaptor

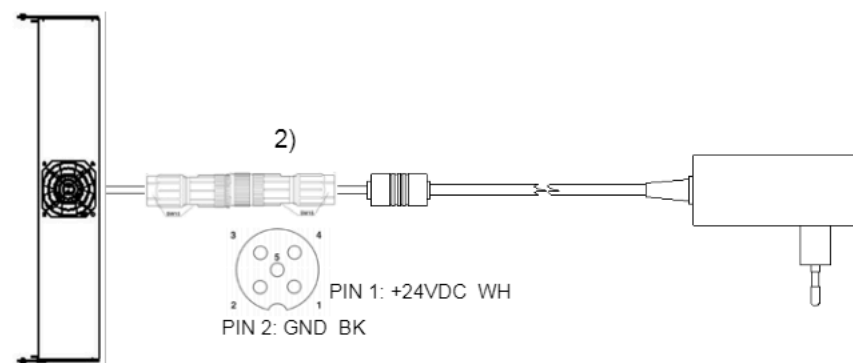

Figure No. 28 Power Cap with AC-adaptor

- 1) Disconnect the plug.
- 2) Connect the sensor/actuator socket, part no.: 0030626 (special accessories).

## 9 Maintenance

The cooling of the inverters 008K – 020K is done exclusively through the natural convection. For safe operation according to the environment the cooling fins on the heat sink should be checked against dirt and if necessary clean up of dust / dirt.

The DC switch is designed for a very long life but it is advised to do some simple yearly maintenance.

By operating the switch a few times (5x) the contacts will clean themselves and the switch will have a longer life.

Other maintenance work is not required.

## 10 Technical Data

### 10.1 Inverters

Type	REFUso/ 008K	REFUso/ 010K	REFUso/ 013K	REFUso/ 017K	REFUso/ 020K
<b>DC data</b>					
Max. PV power	8,8 kW	11 kW	13,6 kW	18,1 kW	21,2 kW
MPPT range	380 – 850 V	380 – 850 V	420 – 850 V	445 – 850 V	480 – 850 V
Max. DC voltage	1000 V				
Max. DC current	23 A	25 A	30 A	38,5 A	41 A
MPP tracking	One fast, precise MPP tracker				
Internal overvoltage protection	Type 3				
Number of DC-connections	3 x MC4		4 x MC4	6 x MC4	
<b>AC data</b>					
Rated AC power	8,25 kVA	10 kVA	12,4 kVA	16,5 kVA	19,2 kVA
Max. AC power	8,25 kW	10 kW	12,4 kW	16,5 kW	19,2 kW
AC grid connection	3AC 400 V+N, 50 / 60 Hz				
Cos $\varphi$	0.9i ... 1... 0.9c				
Max. AC current	12 A	18 A		29 A	
MCB characteristic: B*	20 A			32 A	
Distortion factor THD	<2,5 %	1,8 %			
Max. efficiency	98,0 %			98,2 %	
Efficiency	97,3 %	97,4 %	97,5 %	97,8 %	
Infeed from	20 W				
Internal consumption in night operation	<0.5 W				
Internal overvoltage protection	Type 3				
<b>Interfaces</b>					
Ethernet interface	1				
Ethernet interface type	RJ45 port				
RS485 interface	1 (IN / OUT)				
RS485 interface type	Round plug connector SACC-M12MS-4SCSH				
<b>Cooling, ambient conditions, EMC</b>					
Cooling	Natural convection				
Ambient temperature	-25 °C to + 55 °C				
Site altitude	Up to 2000 m above sea level				
Noise	<45 dBa				



Type	REFUso/ 008K	REFUso/ 010K	REFUso/ 013K	REFUso/ 017K	REFUso/ 020K
Emitted interference	EN 61000-6-4; 2007				
Certificate	CE (UL and CSA in preparation)				
Interference immunity	EN 61000-6-2; 2005				
Environmental classification	4K4H according to DIN IEC 721-3-3				
Automatic disconnection (SZS)	Acc. To VDE 0126-1-1				
Grid code	Complies with all of the German low and medium voltage grid regulations (VDEW, BDEW, VDE-AR-N 4105, EEG2009)				
Type of protection	IP65 as per EN 60529				
Dimensions Width / Height / Depth	535 mm / 601 mm / 277 mm				
Weight	30 kg		35,5 kg		41,5 kg

\* Please observe the derating conditions in case automatic circuit-breakers are mounted side by side!

## 10.2 Radiation and temperature sensor

Type	Si-13TC-T-K
<b>General</b>	
Shunt resistor	0,10 $\Omega$ (TK = 22 ppm/K)
Ambient temperature	-20 °C to +70 °C
Supply voltage	12 to 24 VDC
Current draw	0,3 mA
Connecting cable	4 x 0,14 mm <sup>2</sup> , 3 m (UV-resistant)
Cell dimension	50 mm x 34 mm
Dimensions Length / Width / Height	145 mm x 81 mm x 40 mm
Weight	340 g
<b>Solar radiation</b>	
Measuring range	0 to 1300 W/m <sup>2</sup>
Output signal	0 to 10 V
Measuring accuracy	±5% of final value
<b>Module temperature</b>	
Measuring range	-20 °C to +90 °C
Output signal	$2.268V + T [^{\circ}C] * 86.9 \text{ mV}/^{\circ}C$
Measuring accuracy	±1.5% at 25 °C
Nonlinearity	0.5 °C
Max. deviation	2 °C
Orange	Output signal radiation (0 - 10 V)
<b>Pin assignment</b>	
Red	Supply voltage (12 - 24 VDC)
Black	GND
Brown	Output signal temperature (0 - 10 V)
Supply voltage	Temperature and radiation sensor or Power cap

### 10.3 Power Cap

Type	REFUso <sup>®</sup> Power Cap
<b>Electrical data</b>	
supply voltage	24VDC
connection supply voltage	sensors connector
Internal consumption	2,4W
<b>Cooling, ambient conditions</b>	
free space in front of the unit	1000 mm
Type of protection	IP54 as per EN 60529
Dimensions Wide / Höhe / Depth	488 mm / 90 mm / 250 mm
Weight	1,4 kg

## 11 Contact

Please address any questions on the configuration of your inverter to:

REFUsol GmbH

Uracherstr. 91

D-72555 Metzingen, Germany

Phone: +49 (0) 7123.969-102

Fax: +49 (0) 7123.969-333

[info@refusol.com](mailto:info@refusol.com)

[www.refusol.com](http://www.refusol.com)

Please address any questions on failures or technical problems to:

Service hotline: +49 (0)7123 / 969 – 202 ((Monday – Friday, 8 a.m. to 5 p.m)

Fax: +49 (0)7123 / 969 – 235

E-mail: [service@refusol.com](mailto:service@refusol.com)

**You should have the following data at hand:**

- Exact description of the error and if possible HEX code of the error (P0017.00).
- Data from the type plate:

**REFUSOL** REFUSOL GmbH  
Uracher Str. 91  
72555 Metzingen / Germany  
[service@refusol.com](mailto:service@refusol.com)  
Hotline: +49 7123969-202

Photovoltaic String Inverter

**Typ: 802R020** 020 REFUSOL 020K HW00

DC Max. Eingangsspannung DC max. input voltage	1000 V	AC Nenn-Betriebsspannung AC nominal operating voltage	3AC400V + N
DC MPP Bereich DC MPP range	480 - 850 V	AC Nenn-Betriebsfrequenz AC nominal operating frequency	50/60 Hz
DC Max. Eingangsstrom gesamt DC max. input current total	41,0 A	AC Nennleistung AC rated power	19.200 VA
DC Max. Strom pro Anschlusspaar/-tripel DC max. input current per input pair/-triplet	25 A	AC Max. Wirkleistung AC max. active power	19.200 W
Betriebstemperaturbereich Operating temperature range	-25...+55 °C	AC Max. Ausgangsstrom AC max. output current	3 x 29,0 A
Gehäuseschutzart Enclosure	IP65	Überspannungskategorie Overvoltage category	II

069000020

Serial-Nummer: 069000020 Made in Germany

## 12 Certificates

The following certificates

- EC Declaration of Conformity
- VDEW Declaration of Conformity
- Clearance Certificate can be downloaded from the REFUsol/ GmbH homepage [www.refusol.com](http://www.refusol.com)

## 13 Notes

REFUso/ GmbH  
Uracher Straße 91  
72555 Metzingen  
Germany

Phone +49 7123 969-102

Fax +49 7123 969-333

[info@refusol.com](mailto:info@refusol.com)

[www.refusol.com](http://www.refusol.com)

Part-No. 0030776

